



# Fire & Acoustic Floor System Installation Manual

# Content

1	BACKGROUND	3
2	SCOPE	3
	2.1 Make sure your information is up to date	3
3	PRODUCT AND ACCESSORIES	4
4	SAFE WORKING PRACTICES	5
	4.1 Stay healthy when working with building products containing crystalline silica	5
	4.2 Avoid breathing in crystalline silica dust!	5
	4.3 Storage and delivery	6
	4.4 Tips for safe and easy handling	6
5	INSTALLATION	7
	5.1 Secura™ Interior Flooring - Floating Floor	7
	5.2 Ceiling Installation	10
	5.3 Floor Penetrations	10
	5.4 Ceiling Penetrations	10
	5.5 Concrete Floor	13
6	PRODUCT INFORMATION	14
	6.1 General	14
	6.2 Product Mass	14
	6.3 Durability	14
	6.4 Fire Properties	14
	PRODUCT WARRANTY	15

## WE VALUE YOUR FEEDBACK

To continue with the development of our products and systems, we value your input. Please send any suggestions, including your name, contact details, and relevant sketches to:

**Ask James Hardie™**  
[literaturefeedback@jameshardie.co.nz](mailto:literaturefeedback@jameshardie.co.nz)

# 1 Background

James Hardie has developed an acoustic floating floor system using timber joists or concrete floor that is suitable for use as an intertenancy floor. Clause G6 'Airborne and Impact Sound' of the New Zealand Building Code (NZBC), the Sound Transmission Class (STC) and the Impact Insulation Class (IIC) dictate that the acoustic standard for intertenancy floors shall be no less than 55. The James Hardie acoustic floor system has been tested and verified to achieve STC 67 and IIC 57. The system has also been tested and verified to have a fire rating up to 60/60/60 FRR. The acoustic performance of the system therefore well exceeds the minimum requirement of Clause G6 of the NZBC. (The acoustic performance of this system has been verified through independent testing at Auckland University and fire performance has been tested/assessed by BRANZ).

# 2 Scope

Secura™ Interior Flooring system as per this installation manual is suitable for use in dry or wet area applications for buildings within the scope of the NZS 3604, 'Timber-framed buildings' or buildings covered by specific engineering design (SED) with a maximum concentrated load of 2.7kN applied over an area of 0.025m<sup>2</sup> as per Table-3 of AS/NZS 1170.1 'Structural Design Actions – Permanent, Imposed and other Actions'.

Note: For higher floor loadings as per AS/NZS 1170.1 for public buildings which are subject to crowding, storage of materials or heavy loadings etc., HardiePanel™ Compressed Sheet must be used for these applications.

## 2.1 MAKE SURE YOUR INFORMATION IS UP TO DATE

---

When specifying or installing James Hardie products, ensure you have the current manual. If you're not sure you do, or you need more information, visit [www.jameshardie.co.nz](http://www.jameshardie.co.nz) or Ask James Hardie on 0800 808 868.



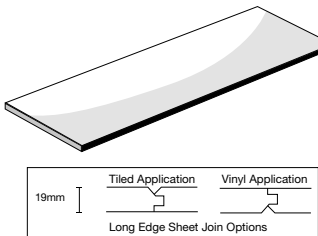

# 3 Product and accessories

Table 1

James Hardie product information			
Product	Description	Size (mm)	Code
	<p>A structural flooring product sealed on all six sides for both tiled or heavy grade vinyl covered internal wet and dry area flooring applications. Long edges have a tongue and groove for easy jointing across the joists.</p> <p><b>Tiled applications:</b> Install sheet with label 'This side down for Tiles' facing down</p> <p><b>Vinyl/planks/carpet application:</b> Install sheet with label 'This side up for Vinyl' facing up</p>	2700 x 600	<b>404260</b>









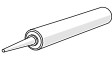
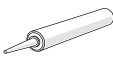

All dimensions provided are approximate only and subject to manufacturing tolerances

Table 2

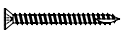
Accessories/tools supplied by James Hardie		
Accessories	Description	Code
	<b>HardieBlade™ Saw Blade</b> HardieBlade Saw Blade 185mm diameter Used to cut Secura Interior Flooring	<b>300660</b>
	James Hardie Acoustic Floor Channel – 40 x 42 x 1800mm	<b>305922</b>
	James Hardie Acoustic Cradle	<b>305920</b>
	James Hardie Flooring Shims	<b>305925</b>

## Accessories not supplied by James Hardie

James Hardie recommends the following products for use in conjunction with its flooring products. James Hardie does not supply these products and does not provide a warranty for their use. Please contact the component manufacturer for information on their warranties and further information on their products.

Accessories	Description	Accessories	Description
	<b>Backing rod</b> PEF backing rod to be used with sealant in control joints.		<b>Waterproofing membrane</b> Used over the Secura Interior Flooring in wet areas. Recommended products from Sika, Ardex, Bostik. Refer to manufacturer for further information.
	<b>Acoustic sealant</b> Sealant used in v joint and around penetrations. Ensure the sealant is compatible with the waterproofing membrane system selected.		<b>Adhesive</b> Adhesive used over joists prior to installation of Secura Interior Flooring. Bostik Seal 'n' Flex 1 Sika Sikaflex 11FC Holdfast 220LM
	<b>Level/straight edge</b> For checking straightness of underlying flooring.		<b>Screws for timber</b> 10g x 40mm wood thread self embedding screws.
	<b>Paslode® Impulse FrameMaster</b>		<b>Screws for steel</b> 8-10g x 40-45mm wing tek min. class 3 coating.
	or <b>ECKO Hammahand®</b>		<b>Nails for timber</b> 50 x 2.87mm stainless steel ring RounDrive nail 50 x 2.87mm Dekfast HD galvanised RounDrive nail
	<b>Allproof Acoustic Pipe Sleeve</b> or similar		<b>Fire collar</b> Allproof drop in fire collar

# 4 Safe working practices

## 4.1 STAY HEALTHY WHEN WORKING WITH BUILDING PRODUCTS CONTAINING CRYSTALLINE SILICA

---

### Crystalline Silica

What is it? Why and when is it a health hazard?

### Crystalline Silica is

- Commonly known as sand or quartz
- Found in many building products e.g. concrete, bricks, grout, wallboard, ceramic tiles, and all fibre cement materials

### Why is Crystalline Silica a health hazard?

- Silica can be breathed deep into the lungs when present in the air as a very fine (respirable) dust
- Exposure to silica dust without taking the appropriate safety measures to minimise the amount being breathed in, can lead to a potentially fatal lung disease – silicosis – and has also been linked with other diseases including cancer. Some studies suggest that smoking may increase these risks
- The most hazardous dust is the dust you cannot see!

### When is Crystalline Silica a health hazard?

- It's dangerous to health if safety protocols to control dust are not followed when cutting, drilling or rebating a product containing crystalline silica
- Products containing silica are harmless if intact (e.g. an un-cut sheet of wall board)

**FAILURE TO ADHERE TO OUR WARNINGS, SAFETY DATA SHEETS AND INSTALLATION INSTRUCTIONS WHEN WORKING WITH JAMES HARDIE PRODUCTS MAY LEAD TO SERIOUS PERSONAL INJURY OR DEATH.**

## 4.2 AVOID BREATHING IN CRYSTALLINE SILICA DUST!

---

### Safe working practices

- 👎 NEVER use a power saw indoors or in a poorly ventilated area
- 👎 NEVER dry sweep
- 👍 ALWAYS use M Class extractor unit as a minimum and always hose down with water/wet wipe for clean up
- 👎 NEVER use grinders
- 👍 ALWAYS use a circular sawblade specifically designed to minimise dust creation when cutting fibre cement – preferably a sawblade that carries the HardieBlade™ logo or one with at least equivalent performance
- 👍 ALWAYS follow tool manufacturers' safety recommendations
- 👍 ALWAYS expose only the minimum required depth of blade for the thickness of fibre cement to be cut
- 👍 ALWAYS wear an approved properly-fitted, approved dust mask (P1 or P2) or respirator

Use one of the following methods based on the required cutting rate:

### BEST

- HardieKnife™
- Hand guillotine
- Fibreshear

### BETTER

- Dust reducing circular saw equipped with HardieBlade™ Saw Blade and M Class extractor unit

### Working outdoors

- 👍 Make sure you work in a well ventilated area
- 👍 Position cutting station so wind will blow dust away from yourself and others in the working area
- 👍 Cut products with either a HardieKnife or fibre cement shears or, when not feasible, use a HardieBlade™ Saw Blade (or equivalent) and a dust-reducing circular saw attached to a M Class extractor unit
- 👍 When sawing, sanding, rebating, drilling or machining fibre cement products, always:
  - Wear your P1 or P2 mask (correctly fitted in accordance with manufacturers' instructions) and when others are close by, ask them to do the same
  - If you are not clean shaven, then use a powered air respirator with a loose fitting head top
  - Wear safety glasses
  - Wear hearing protection
  - When others are close by, ask them to do the same

### Working indoors

- 👎 Never cut using a circular saw indoors
- 👍 Position cutting station in a well ventilated area
- 👍 Cut ONLY using a HardieKnife, hand guillotine or fibreshears (manual, electric or pneumatic)
- 👍 Make sure you clean up BUT never dry sweep. Always hose down with water/wet wipe or use an M Class extractor unit

**IF CONCERN STILL EXISTS ABOUT EXPOSURE LEVELS OR YOU DO NOT COMPLY WITH THE ABOVE PRACTICES, YOU SHOULD ALWAYS CONSULT A QUALIFIED INDUSTRIAL HYGIENIST.**

### Working instructions

- Refer to Recommended Safe Working Practices before starting any cutting or machining of product.

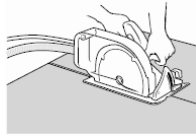

### HardieBlade™ Saw Blade

The HardieBlade™ Saw Blade used with a dust-reducing saw is ideal for fast, clean cutting of James Hardie fibre cement products. A dust-reducing saw uses a dust deflector or a dust collector connected to a vacuum system. When sawing, clamp a straight-edge to the sheet as a guide and run the saw base plate along the straight edge when making the cut.



### Hole-forming

#### For smooth clean cut circular holes:

- Mark the centre of the hole on the sheet
- Pre-drill a 'pilot' hole
- Using the pilot hole as a guide, cut the hole to the appropriate diameter with a hole saw fitted to a heavy duty electric drill

#### For irregular holes:

- Small rectangular or circular holes can be cut by drilling a series of small holes around the perimeter of the hole then tapping out the waste piece from the sheet face
- Tap carefully to avoid damage to sheets, ensuring that the sheet edges are properly supported

## 4.3 STORAGE & DELIVERY

### Keeping products and people safe

#### Off loading

- 👍 James Hardie products should be off-loaded carefully by hand or by forklift
- 👍 James Hardie products should not be rolled or dumped off a truck during the delivery to the jobsite

#### Storage

##### James Hardie products should be stored:

- 👍 In their original packaging
- 👍 Under cover where possible or otherwise protected with a waterproof covering to keep products dry
- 👍 Off the ground – either on a pallet or adequately supported on timber or other spacers
- 👍 Flat so as to minimise bending

##### James Hardie products must not be stored:

- 👎 Directly on the ground
- 👎 In the open air exposed to the elements

**JAMES HARDIE IS NOT RESPONSIBLE FOR DAMAGE DUE TO IMPROPER STORAGE AND HANDLING.**

## 4.4 TIPS FOR SAFE AND EASY HANDLING

### Weatherboard products

- 👎 Do not lift planked products flat and in the middle
- 👍 Carry the products on the edge
- 👍 If only one person is carrying the product, hold it in the middle and spread arms apart to better support the product
- 👍 If two people are carrying the plank, hold it near each end and on edge
- 👍 Exercise care when handling weatherboard products to avoid damaging the edges/corners

### Sheet products

- 👍 Carry with two people
- 👍 Hold near each end and on edge
- 👍 Exercise care when handling sheet products to avoid damaging the edges/corners

Figure 1: First sheet installation

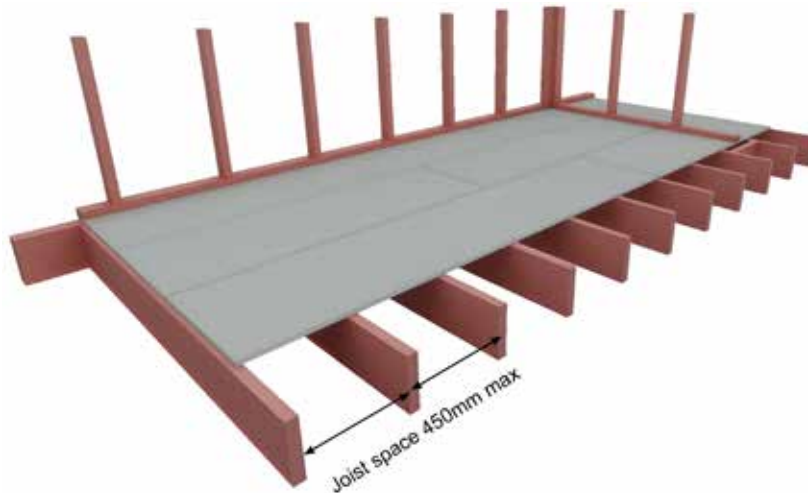

## 5 Installation

James Hardie fire and acoustic floor system is built using the standard floor construction methodologies used in light weight timber frame building construction. The floor system uses two layers of Secura Interior Flooring, the first layer is fixed to the timber floor joists and the second layer fixed into the steel channels over the rubber cradle creating a floating floor.

Secura Interior Flooring over joists:

**Refer to Secura Interior Flooring Installation Manual for detailed information regarding its installation.**

- Solid timber floor joists sizes can be selected as per the NZS 3604 design tables
- Alternatively hySpan/hyJoist floor joists can also be used for the construction of this floor system
- Joist spacing must be at 450mm maximum centres
- Secura Interior Flooring must be laid across the joists
- A bead of adhesive e.g. Sikaflex 11FC, Bostik Seal n Flex-1 or Holdfast 220LM be applied over the joists before fixing the sheets
- The long sheet edges are manufactured with a tongue and groove edge. The long sheet edges are to be butted to form a tight tongue and groove joint. Tap the sheets tight using a wooden block along the edge to avoid damaging the edge
- Run Secura Interior Flooring across the floor joists and fix flooring sheets using annular grooved gun nails 50 x 2.87mm, or they can also be screw fixed using a 50mm x 10g timber thread self-embedding screws at 200mm centres maximum to floor joists

After the floor installation has been completed, the construction above the floor should be carried out as per the normal practice. Once the internal walls have been completed with internal lining, the installation of the second layer of Secura Interior Flooring can commence.

Note: Secura Interior Flooring can be used as a diaphragm floor. Refer to James Hardie Bracing Design Manual.

### 5.1 SECURA INTERIOR FLOORING – FLOATING FLOOR

- Position the James Hardie Acoustic Cradles on the floor starting from one edge of the room. The cradles allow the placement of James Hardie Acoustic Floor Channel over it. Acoustic cradles must be placed at 450mm centres maximum along the length of channel. Minimum requirement at 7 cradles/m<sup>2</sup> of the floor area. Refer to Figure 3
- James Hardie Acoustic Cradles are placed along the perimeter of room with a 10mm gap from the internal lining. Refer to Figures 3 and 6
- Place the James Hardie Acoustic Channel into the Acoustic Cradle. The maximum spacing between the channels must not exceed 450mm centres. The Acoustic Channels can run in either direction of the room i.e. independent of the floor joist or Secura Interior Flooring layout
- Acoustic insulation 75mm thick (density 9.6kg/m<sup>3</sup> minimum) tightly fitted in between the Acoustic Channels to create a damping effect

Figure 2: Fastener layout

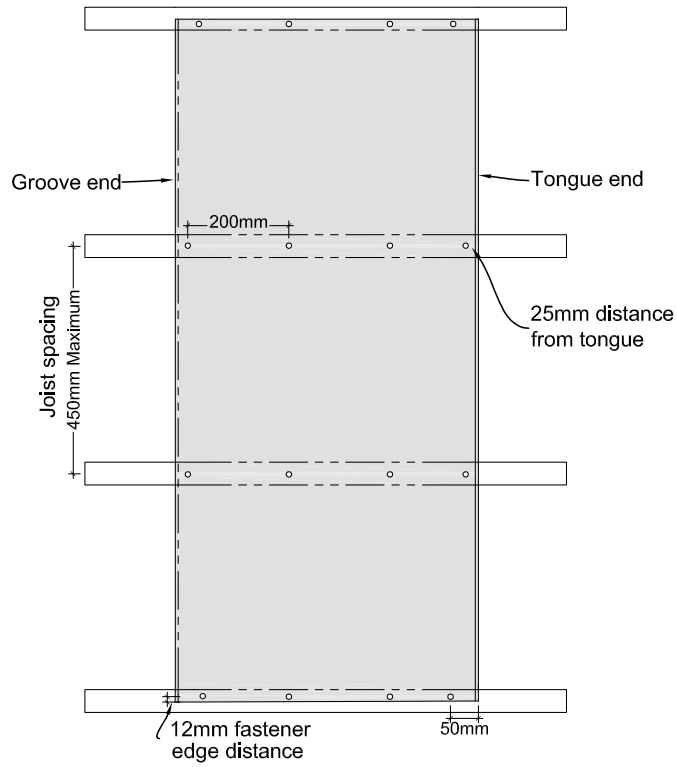

Figure 3: Batten and cradle layout

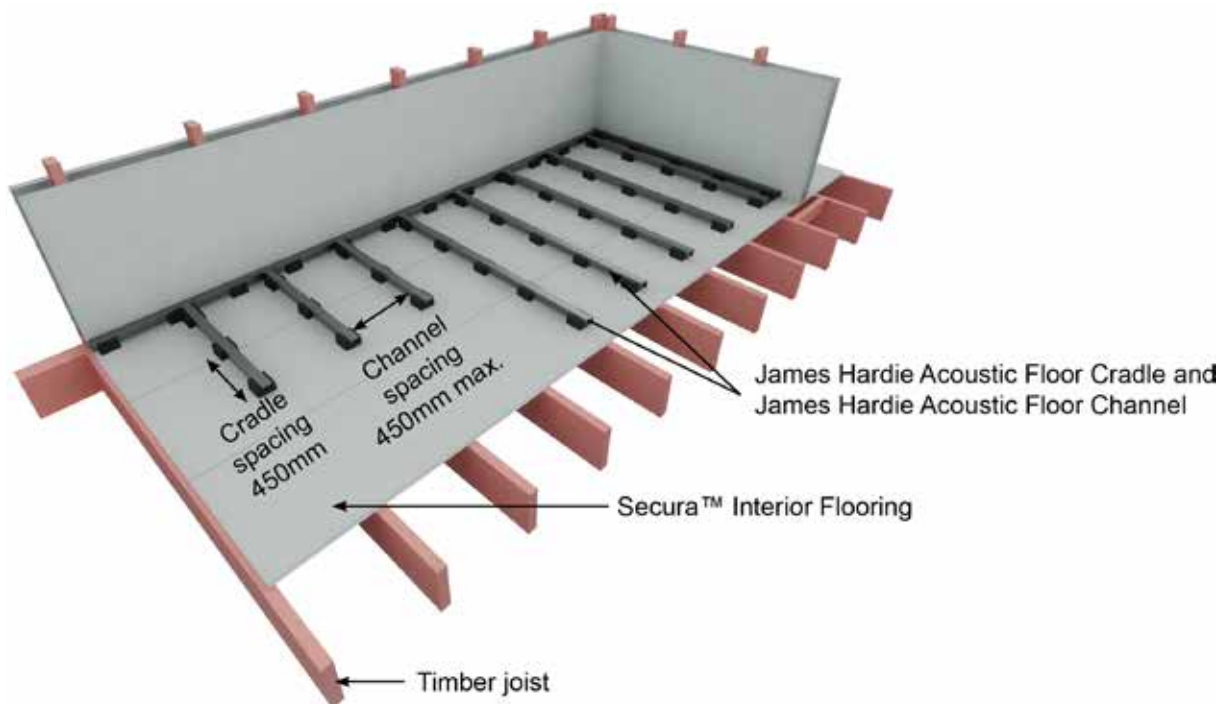



Figure 4: Insulation installation

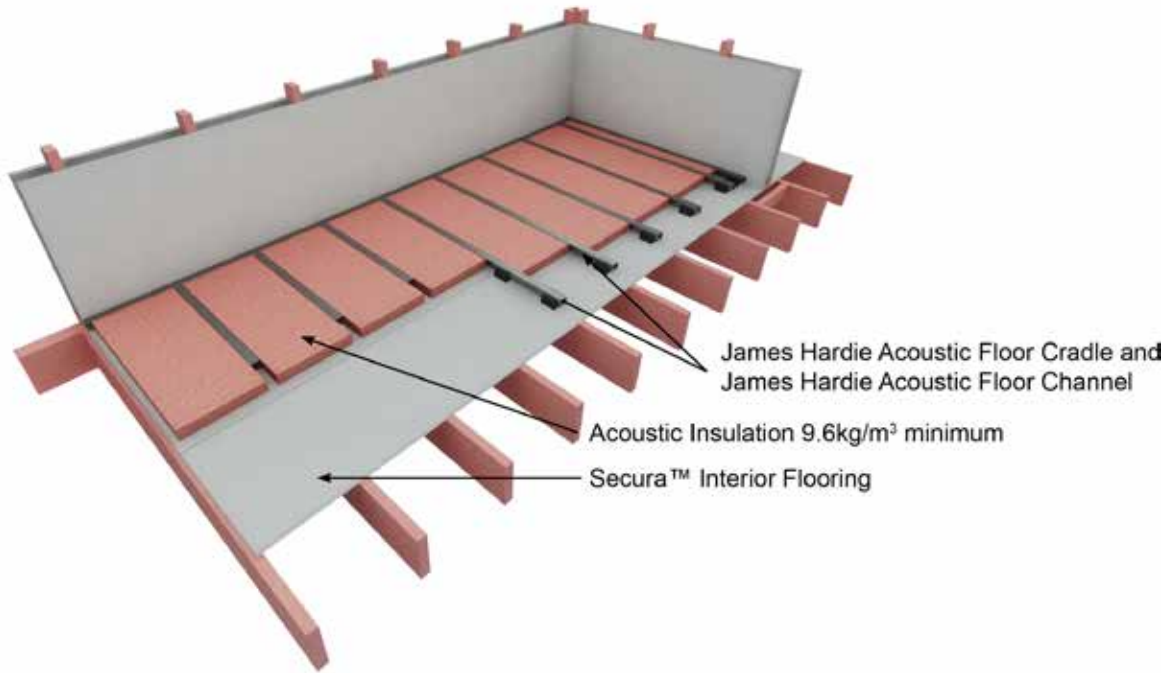

Figure 5: Second sheet installation

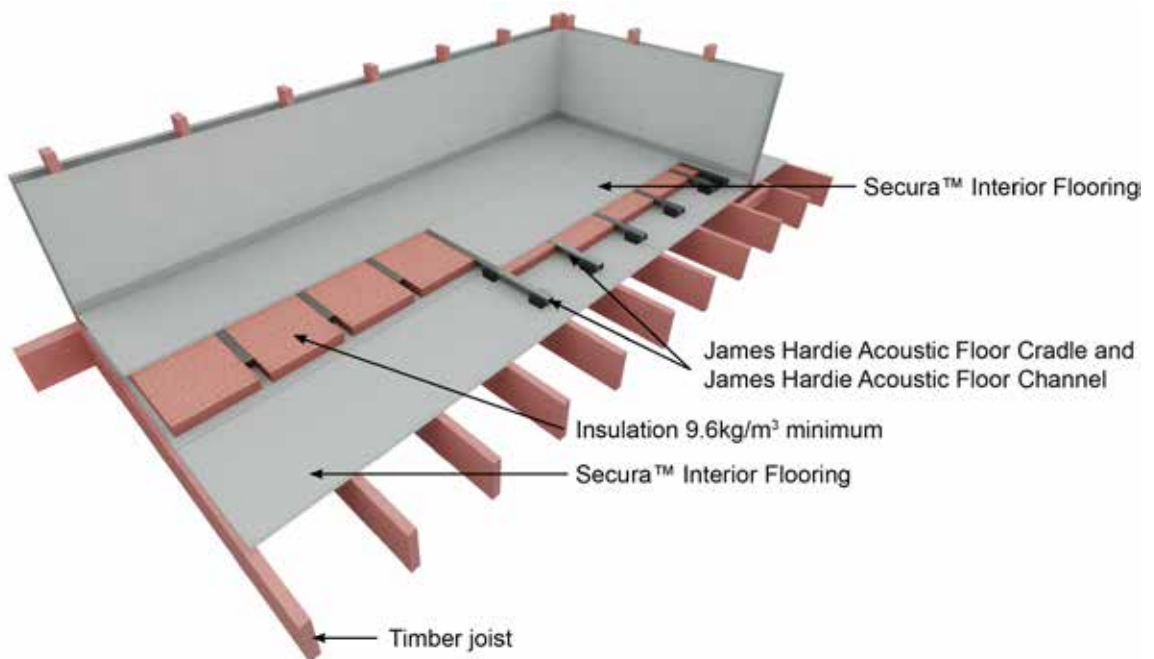
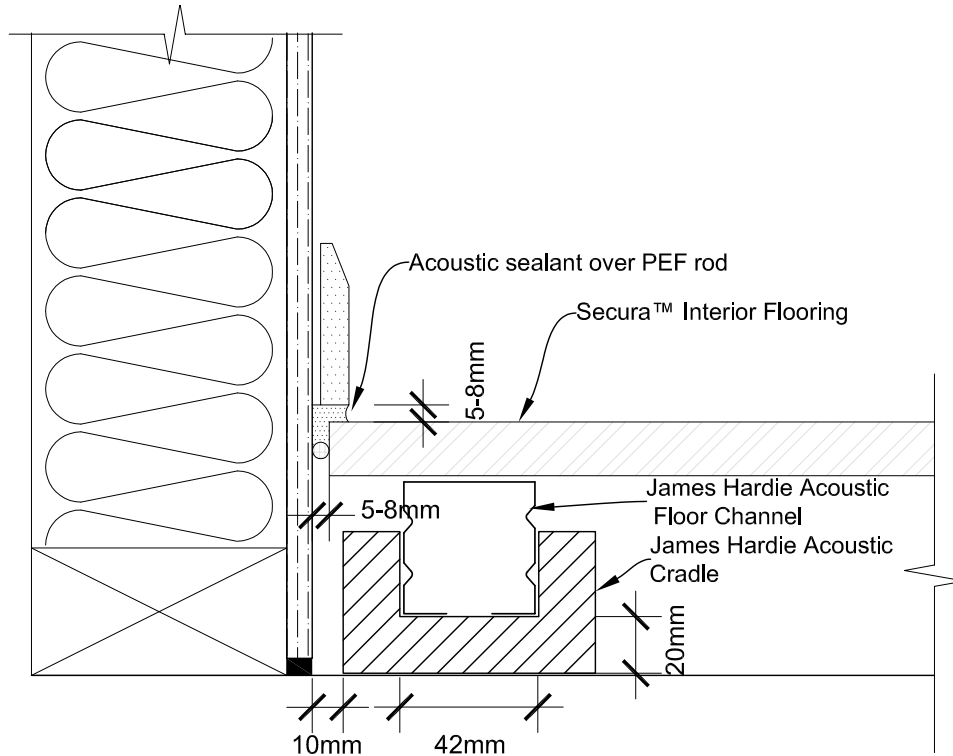

Figure 6: Floor to wall junction



- Lay Secura Interior Flooring across the Acoustic Channel and fix to the Acoustic Channels using a 50mm x10g self-tapping steel screw at 200mm centres along the channel. The long sheet edges are to be butted together to form a tight tongue and groove joint. Refer to Figure 5
- Allow a 5-8mm gap between the Secura Interior Flooring and wall lining around the perimeter. The gap is filled up with a PEF rod and sealed with an acoustic sealant. Refer to Figure 6

## 5.2 CEILING INSTALLATION

The installation of GIB® Rondo® channels and 2 x 13mm GIB Fyrelite® is as per the information published by Winstone Wallboards Limited. Refer to 'GIB® Fire Rated Systems' technical specification for information regarding their installation.

## 5.3 FLOOR PENETRATIONS

For pipe penetrations through the floor cut 10mm oversize hole through the Secura Interior Flooring. Fit the pipe through the penetration and then seal around with an acoustic sealant. Refer Figures 7 and 8.

## 5.4 CEILING PENETRATIONS

Penetrations through a fire rated system, if they are not correctly specified, installed and tested, can allow spread of fire and smoke from one fire cell to another.

As a general guidance Gartner Superlux Limited have tested a few light fittings in conjunction with GIB Fyrelite® for use in fire rated ceiling application. Based on this testing they publish information for the installation of their light fittings as to what is the maximum surface area allowed and minimum distance to be maintained between the light fittings etc. Refer to Gartner Superlux for further information.

It is suggested that the information published in 'GIB® Fire Rated Systems' specification and Gartner Superlux Limited is referred to before specifying any penetrations through a fire rated ceiling. Also check with the proprietary seals manufacturer/supplier for the installation details of their products and its test data.

Figure 7: Services running parallel floor joists

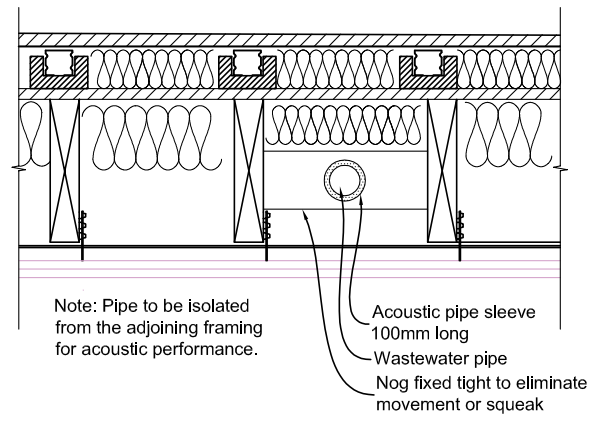
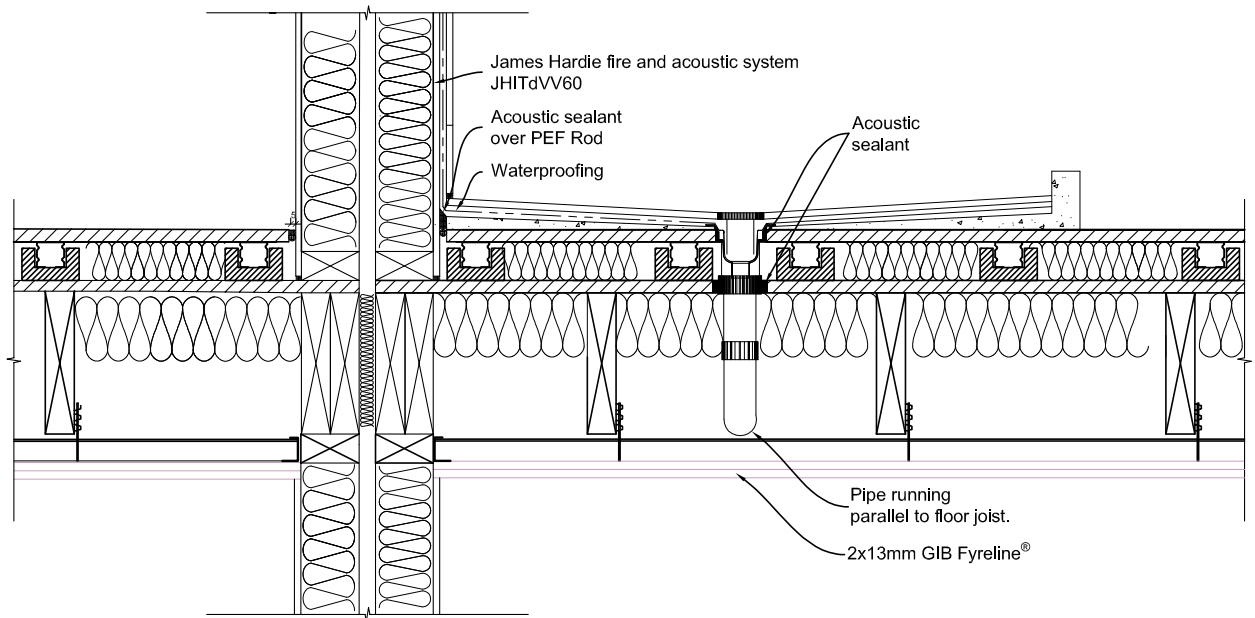
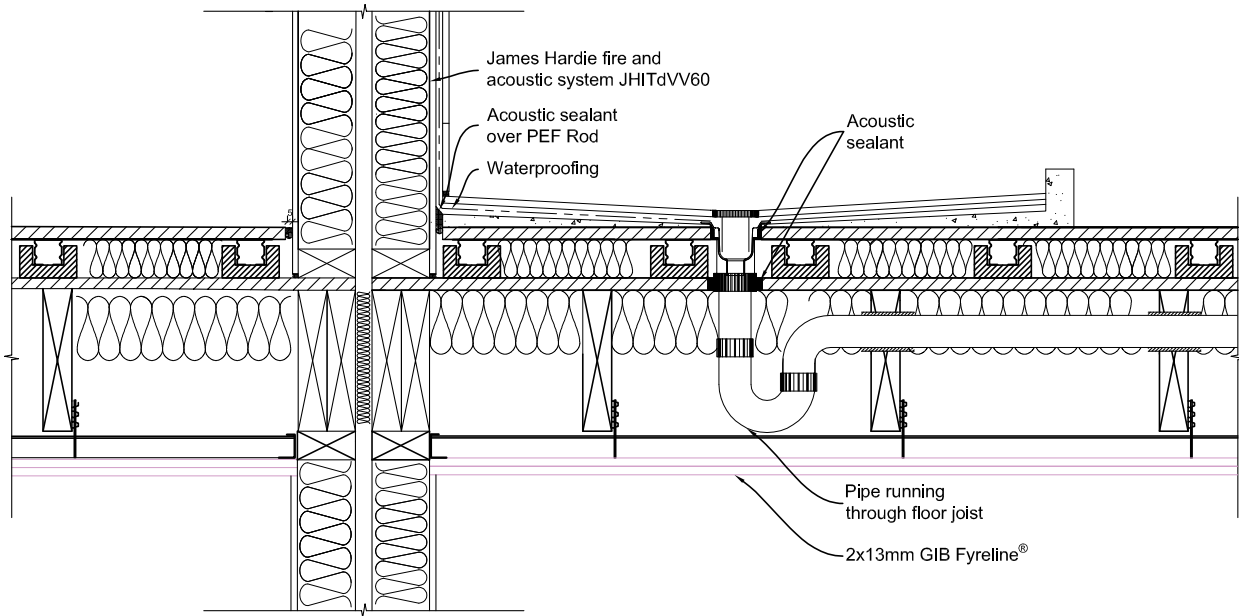
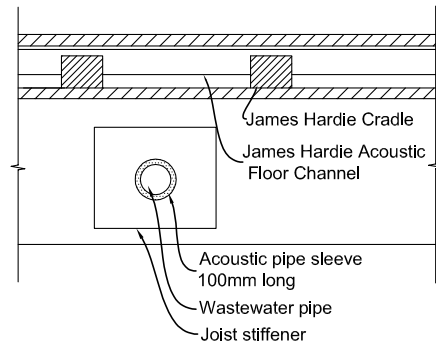

Figure 8: Services running through floor joists



Note: Pipe to be isolated from the adjoining framing for acoustic performance.



## 5.5 CONCRETE FLOOR

When using the concrete floor construction methodology for an intertenancy floor application, ensure the design of concrete floor is suitable to achieve the required fire rating.

To achieve the required Impact Insulation Class (IIC) performance, Secura Interior Flooring can be fixed as a floating floor application over the concrete floor. Refer to Figure 9 for details.

James Hardie has assessed the acoustic performance of various types of concrete floor solutions in conjunction with Secura Interior Flooring as a floating floor.

The acoustic performance of a typical tray deck concrete floor construction as per Figure 9 is STC 70 and IIC 58.

Contact James Hardie for any further information on acoustic performance of floors.

Figure 9: Concrete floor

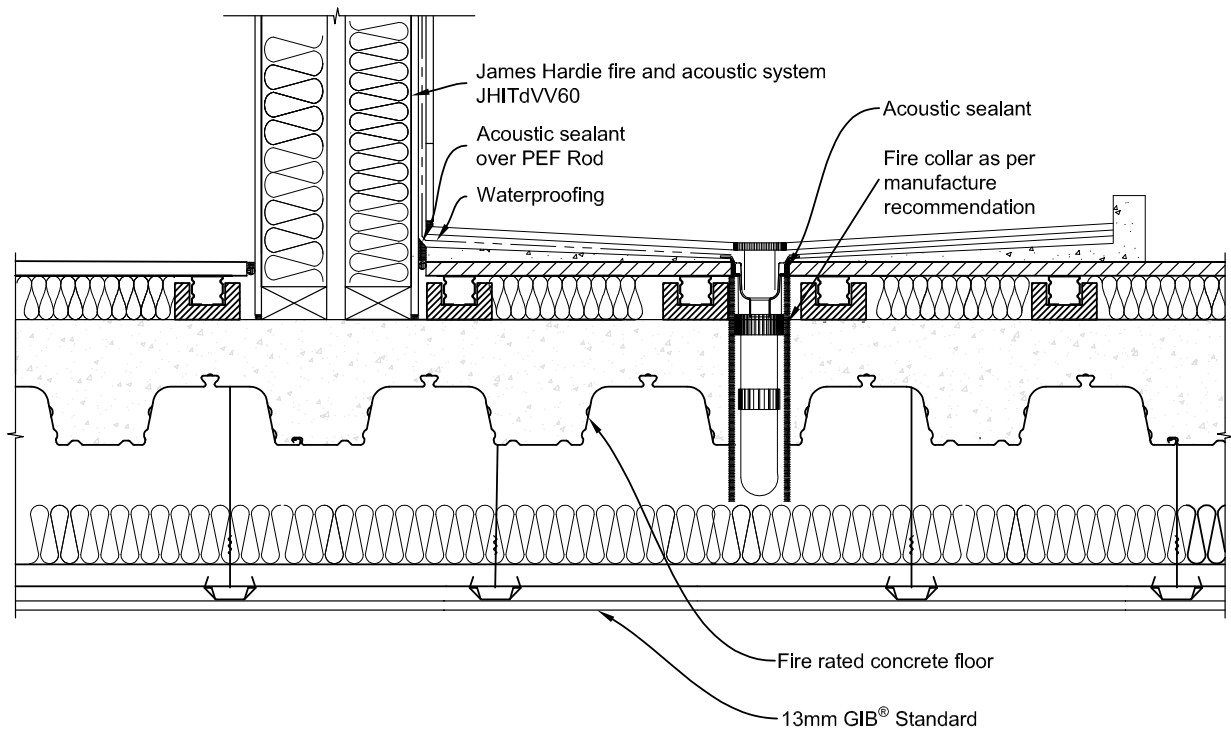

# 6 Product information

## 6.1 GENERAL

---

Secura Interior Flooring is an advanced lightweight cement composite building product. The basic composition is Portland cement, ground sand, cellulose fibre and water.

Secura Interior Flooring is manufactured to AS/NZS 2908.2 'Cellulose- Cement Products Part 2: Flat Sheets' (ISO 8336 'Fibre Cement Flat Sheets').

Secura Interior Flooring is a classified Type B, Category 2 in accordance with AS/NZS 2908.2 'Cellulose-Cement Products'.

## 6.2 PRODUCT MASS

---

Based on equilibrium moisture content the approximate mass of:

- Secura Interior Flooring is 24.5kg/m<sup>2</sup>.

## 6.3 DURABILITY

---

### Resistance to moisture/rotting

Secura Interior Flooring has demonstrated resistance to permanent moisture induced deterioration (rotting) by having passed the following tests in accordance with AS/NZS 2908.2:

- Heat rain (Clause 6.5)
- Water permeability (Clause 8.2.2)
- Warm water (Clause 8.2.4)
- Soak dry (Clause 8.2.5)

## 6.4 FIRE PROPERTIES

---

Secura Interior Flooring is classified as a non-combustible material. Secura Interior Flooring is suitable for use in intertenancy fire rated floor applications and has been tested to meet performance requirements.

# Product Warranty



James Hardie New Zealand Limited ("James Hardie") warrants for a period of 15 years from the date of purchase that the Secura™ Interior Flooring (the "Product"), will be free from defects due to defective factory workmanship or materials and, subject to compliance with the conditions below, will be resistant to cracking, rotting, fire and damage from termite attacks to the extent set out in James Hardie's relevant published literature current at the time of installation. James Hardie warrants for a period of 12 months from the date of purchase that the accessories supplied by James Hardie will be free from defects due to defective factory workmanship or materials.

Nothing in this document shall exclude or modify any legal rights a customer may have under the Consumer Guarantees Act or otherwise which cannot be excluded or modified at law.

## CONDITIONS OF WARRANTY:

The warranty is strictly subject to the following conditions:

- a) James Hardie will not be liable for breach of warranty unless the claimant provides proof of purchase and makes a written claim either within 30 days after the defect would have become reasonably apparent or, if the defect was reasonably apparent prior to installation, then the claim must be made prior to installation;
- b) this warranty is not transferable;
- c) the Product must be installed and maintained strictly in accordance with the relevant James Hardie literature current at the time of installation and must be installed in conjunction with the components or products specified in the literature. Further, all other products, including coating and jointing systems, applied to or used in conjunction with the Product must be applied or installed and maintained strictly in accordance with the relevant manufacturer's instructions and good trade practice;
- d) the project must be designed and constructed in strict compliance with all relevant provisions of the current NZBC, regulations and standards;
- e) the claimant's sole remedy for breach of warranty is (at James Hardie's option) that James Hardie will either supply replacement product, rectify the affected product or pay for the cost of the replacement or rectification of the affected product;
- f) James Hardie will not be liable for any losses or damages (whether direct or indirect) including property damage or personal injury, consequential loss, economic loss or loss of profits, arising in contract or negligence or howsoever arising. Without limiting the foregoing James Hardie will not be liable for any claims, damages or defects arising from or in any way attributable to poor workmanship, poor design or detailing, settlement or structural movement and/or movement of materials to which the Product is attached, incorrect design of the structure, acts of God including but not limited to earthquakes, cyclones, floods or other severe weather conditions or unusual climatic conditions, efflorescence or performance of paint/coatings applied to the Product, normal wear and tear, growth of mould, mildew, fungi, bacteria, or any organism on any Product surface or Product (whether on the exposed or unexposed surfaces);
- g) all warranties, conditions, liabilities and obligations other than those specified in this warranty are excluded to the fullest extent allowed by law;
- h) if meeting a claim under this warranty involves re-coating of Products, there may be slight colour differences between the original and replacement Products due to the effects of weathering and variations in materials over time.

Disclaimer: The recommendations in James Hardie's literature are based on good building practice, but are not an exhaustive statement of all relevant information and are subject to conditions (c), (d), (f) and (g) above. James Hardie has tested the performance of the Secura™ Interior Flooring when installed in accordance with the Secura™ Interior Flooring Installation Manual, in accordance with the standards and verification methods required by the NZBC and those test results demonstrate the product complies with the performance criteria established by the NZBC. However, as the successful performance of the relevant system depends on numerous factors outside the control of James Hardie (e.g. quality of workmanship and design) James Hardie shall not be liable for the recommendations made in its literature and the performance of the relevant system, including its suitability for any purpose or ability to satisfy the relevant provisions of the NZBC, regulations and standards, as it is the responsibility of the building designer to ensure that the details and recommendations provided in the relevant James Hardie installation manual are suitable for the intended project and that specific design is conducted where appropriate.

Copyright April 2019. © James Hardie New Zealand Limited. TM and ® denotes a Trademark or Registered Mark owned by James Hardie Technology Limited.

