

Fire & Acoustic Design Manual

May 2026 New Zealand

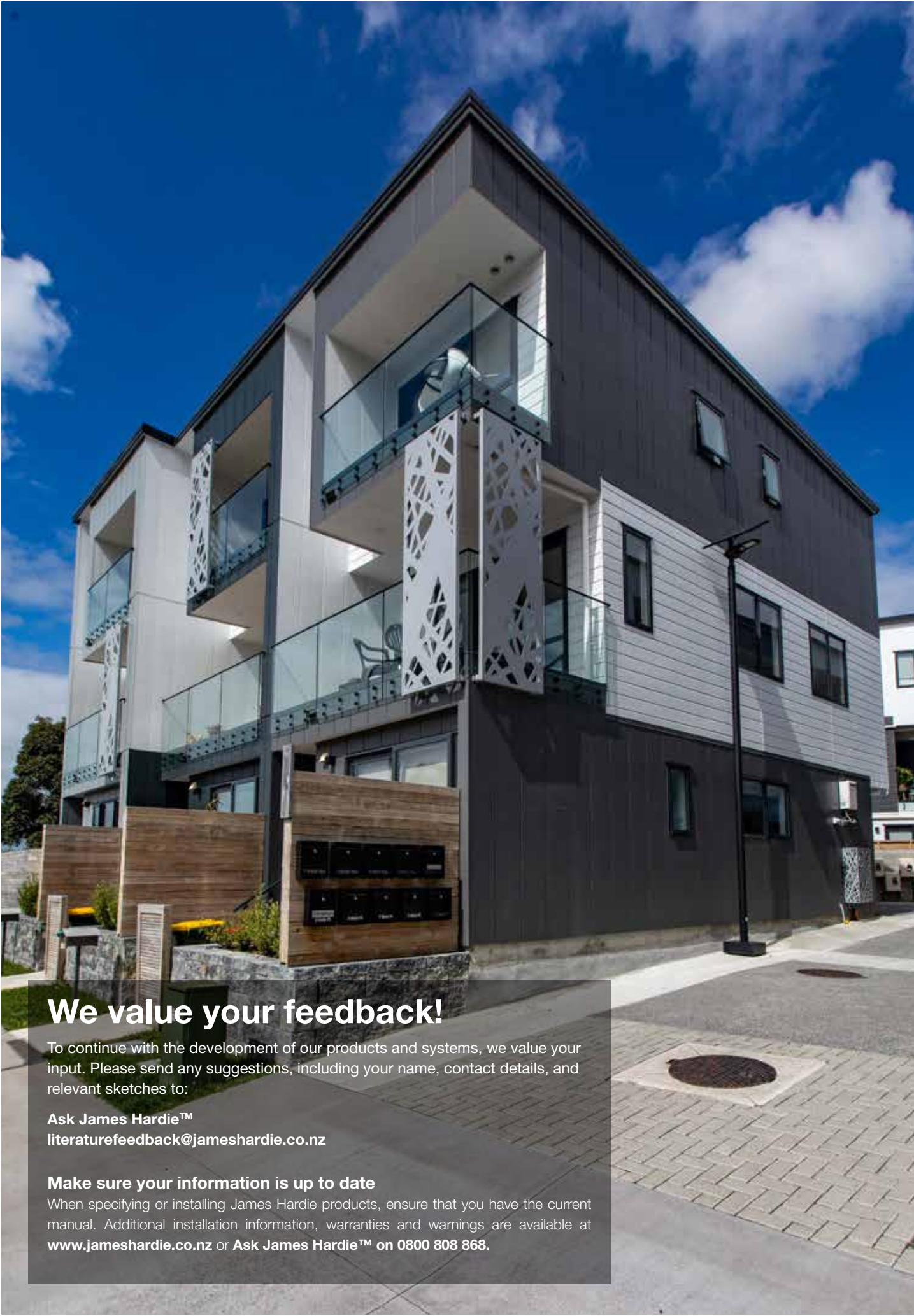



We value your feedback!

To continue with the development of our products and systems, we value your input. Please send any suggestions, including your name, contact details, and relevant sketches to:

Ask James Hardie™
literaturefeedback@jameshardie.co.nz

Make sure your information is up to date

When specifying or installing James Hardie products, ensure that you have the current manual. Additional installation information, warranties and warnings are available at www.jameshardie.co.nz or **Ask James Hardie™** on 0800 808 868.

Contents

1	Introduction	4		
1.1	James Hardie's Fire And Acoustic System Description	4		
2	Application and scope	6		
2.1	Application	6		
2.2	Scope	6		
2.3	Compliance	6		
2.4	Responsibility	6		
2.5	Safe Working Practices	7		
3	Systems Summary Table	8		
3.1	External Walls - Timber Frame	8		
3.2	External Walls - Steel Frame	10		
3.3	Parapet & Wing Walls - Timber Frame	11		
3.4	Internal Walls - Timber Frame	12		
3.5	Internal Floors / Ceilings - Timber Frame	12		
4	Design guidelines	13		
4.1	Boundary Wall – Post Fire Stability	13		
4.2	Acoustic Performance	13		
4.3	Framing	13		
4.4	Timber	14		
4.5	Steel	14		
4.6	Thermal Fire Batten	14		
4.7	Structural Steel Members	15		
4.8	Insulation	15		
4.9	Flexible Underlay	15		
4.10	RAB™ Board	15		
4.11	Cavity Construction	15		
4.12	Control Joints	15		
4.13	Coatings and Finishes	15		
4.14	Bracing	16		
4.15	Fire Resistance Rating	16		
4.16	Internal Linings Group Numbers	16		
4.17	Control Of External Fire Spread	16		
4.18	Product Substitution	17		
4.19	Plasterboard	17		
	External Walls			18
	Timber Frame			
	External Walls			52
	Steel Frame			
	Parapet & Wing Walls			55
	Timber Frame			
	Internal Walls			73
	Timber Frame			
	Internal Floors/Ceilings			78
	Timber Frame			
5	Construction details	80		
5.1	Penetrations	100		
6	Hardie™ Mineral Insulation			106
7	Product Warranty			107

1 Introduction

This manual provides information about **James Hardie's two way fire and acoustic systems** using timber or steel frames in internal or external wall applications.

In terms of the New Zealand Building Code (NZBC) requirements, fire rating performance is referred to as FRR (Fire Resistance Rating) and is measured in minutes e.g. a FRR 30/30/30 means a fire rating for 30 minutes. Further explanation in this matter is provided in section 4.15 of this design manual.

1.1 James Hardie's Fire And Acoustic System Description

Each FRR system is identified by a unique specification number (e.g. JHETLL60) to identify it as one of James Hardie's fire resistance rated wall systems.

The explanation of specification numbers used are as follows:

JHETLL60

JHETOO60h

JHETRR30-A

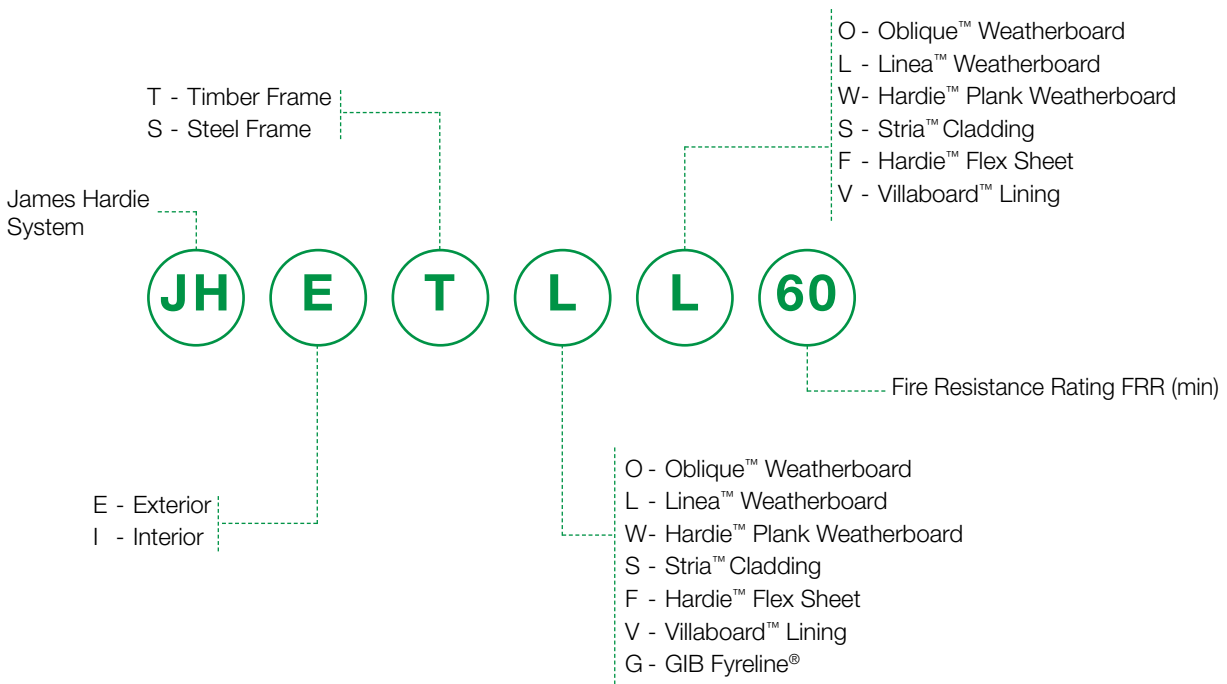

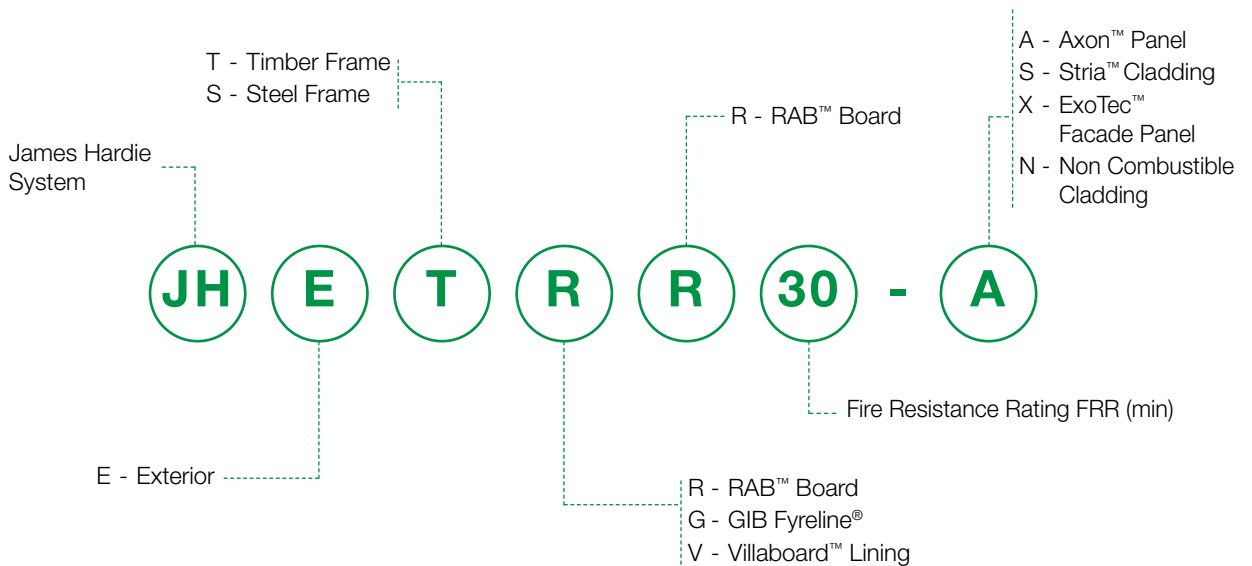
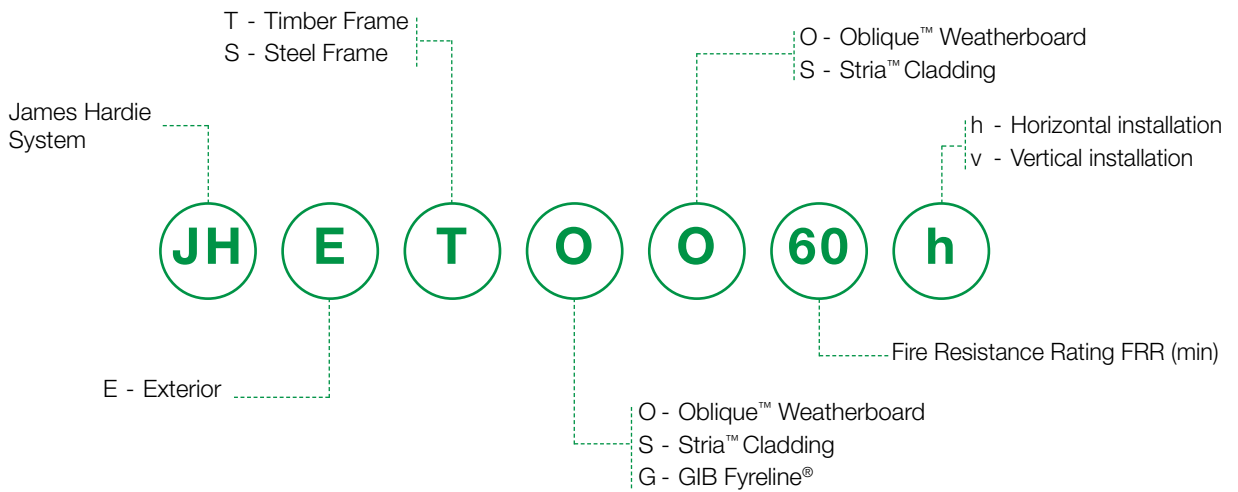

2 Application and scope

2.1 Application

The fire and acoustic rated walls and floor systems described in this design manual can be used in a wide range of applications as indicated in this section. Systems can be used for single or multi level construction.

This manual is intended to assist designers in selecting a suitable Hardie™ fibre cement product and choose a system which will meet their performance requirements.

Various sections in this manual have been arranged to ensure quick familiarisation with James Hardie's fire and acoustic systems. Readers must also familiarise themselves with the relevant Hardie™ fibre cement product literature.

2.2 Scope

The fire and acoustic systems provided in this design manual are suitable for vertical or horizontal fire separation applications. The fire rated systems published are suitable for load bearing walls/floors within the scope of the NZS 3604 and specific engineered design (SED) projects where the minimum framing requirements are followed as per the FRR system specification in this manual. Ask James Hardie™ on 0800 808 868 for further assistance.

2.3 Compliance

The Fire and Acoustic systems by James Hardie have been tested/assessed and are BRANZ appraised.

This BRANZ Appraisal No. 1285 should be read in conjunction with this design manual. The appraisal No. 1285 can be viewed on www.jameshardie.co.nz or www.branz.co.nz.



2.4 Responsibility

Specifier

If you are a designer/specifier ensure that you are familiar with the approved document for Fire Safety, Clause C of the NZBC and check its requirements. Ensure that the information in this document is appropriate for the intended application and that you undertake specific design and detailing for areas which fall outside the scope of this manual.

Installers

If you are an installer ensure that you follow the complete system requirements as mentioned in this manual to achieve the required performance levels. Follow the design, associated details and material selection provided by the designer. The systems provided in this manual must be read and installed in conjunction with the project specifications. Any material specified for a fire rated system, when substituted, will affect the system performance. All Hardie™ fibre cement products shall be installed as per the relevant product technical literature.

Make sure your information is up to date

When specifying or installing products by James Hardie, ensure that you have the current manual. Additional installation information, warranties and warnings are available at www.jameshardie.co.nz or Ask James Hardie™ on 0800 808 868.

James Hardie conducts stringent quality checks to ensure that any product manufactured falls within our quality spectrum. It is the responsibility of the builder to ensure that the product meets aesthetic requirements before installation. James Hardie will not be responsible for rectifying obvious aesthetic surface variations following installation.

2.5 Safe Working Practices

We understand the importance of creating a safe and healthy work environment when using Hardie™ fibre cement products. Refer to recommended safe working practices in each specific product technical manual or visit the working safely with fibre cement page under the resources section of jameshardie.co.nz before starting any cutting or machining of Hardie™ fibre cement products.

3 Systems Summary Table

3.1 External Walls - Timber Frame

30 minute fire rated system					
System #	Description	Insulation	FRR	STC	Page
JHETGL30	Linea™ Weatherboard 10mm GIB Fyreline®	R2.2 glass wool	30/30/30	44	19
JHETGO30h	Oblique™ Weatherboard horizontal 10mm GIB Fyreline®	R2.2 glass wool	30/30/30	43	20
JHETGO30v	Oblique™ Weatherboard vertical 10mm GIB Fyreline®	R2.2 glass wool	30/30/30	43	21
JHETGW30	Hardie™ Plank Weatherboard 10mm GIB Fyreline®	R2.2 glass wool	30/30/30	41	22
JHETGS30h	Stria™ Cladding horizontal 10mm GIB Fyreline®	R2.2 glass wool	30/30/30	42	23
JHETGS30v	Stria™ Cladding vertical 10mm GIB Fyreline®	R2.2 glass wool	30/30/30	42	24
JHETGF30	Hardie™ Flex Sheet 10mm GIB Fyreline®	R2.2 glass wool	30/30/30	40	25
JHETGA30	Axon™ Panel 10mm GIB Fyreline®	R2.2 glass wool	30/30/30	41	26
JHETGR30-A	Axon™ Panel - Hardie™ CLD™ Structural Cavity Batten RAB™ Board 10mm GIB Fyreline®	R2.2 glass wool	30/30/30	42	27
JHETGR30-X	ExoTec™ Facade Panel - Top Hat System RAB™ Board 10mm GIB Fyreline®	R2.2 glass wool	30/30/30	43	28
JHETGR30-B	Brick Cladding min 50mm thick RAB™ Board 10mm GIB Fyreline®	R2.2 glass wool	30/30/30	44	29
JHETGR30-N	Non-combustible/limited combustible cladding complying with C/AS1 or Building Product Specification (BPS) RAB™ Board 10mm GIB Fyreline®	R2.2 glass wool	30/30/30	43	30

60 minute fire rated system

System #	Description	Insulation	FRR	STC	Under 10m	Over 10m or EH/SED Wind Zone
JHETGL60	Linea™ Weatherboard 13mm GIB Fyreline®	R2.2 glass wool	60/60/60	44	Page 31	Page 32
JHETGO60h	Oblique™ Weatherboard horizontal 13mm GIB Fyreline®	R2.2 glass wool	60/60/60	44	Page 33	Page 34
JHETGO60v	Oblique™ Weatherboard vertical 13mm GIB Fyreline®	R2.2 glass wool	60/60/60	44	Page 35	Page 36
JHETGW60	Hardie™ Plank Weatherboard 13mm GIB Fyreline®	Hardie™ Mineral	60/60/60	43	Page 37	
JHETGS60h	Stria™ Cladding horizontal 13mm GIB Fyreline®	R2.2 glass wool	60/60/60	43	Page 38	Page 39 Smooth finish only
JHETGS60v	Stria™ Cladding vertical 13mm GIB Fyreline®	R2.2 glass wool	60/60/60	43	Page 40	Page 41 Smooth finish only
JHETGF60	Hardie™ Flex Sheet 13mm GIB Fyreline®	Hardie™ Mineral	60/60/60	42	Page 42	
JHETGA60	Axon™ Panel 13mm GIB Fyreline®	Hardie™ Mineral	60/60/60	43	Page 43	
JHETGR60-A	Axon™ Panel - Hardie™ CLD™ Structural Cavity Batten RAB™ Board 13mm GIB Fyreline®	Hardie™ Mineral	60/60/60	43	Page 44	
JHETGR60-X	ExoTec™ Facade Panel Top Hat System RAB™ Board 13mm GIB Fyreline®	Hardie™ Mineral	60/60/60	45	Page 45	
JHETGR60-B	Brick cladding min 50mm thick RAB™ Board 13mm GIB Fyreline®	R2.2 glass wool	60/60/60	44	Page 46	
JHETGR60-N	Non-combustible/limited combustible cladding complying with C/AS1 or BPS RAB™ Board 13mm GIB Fyreline®	Hardie™ Mineral	60/60/60	44	Page 47	
JHETVA60	Axon™ Panel Villaboard™ Lining	Hardie™ Mineral	60/60/60	42	Page 48	
JHETVL60	Linea™ Weatherboard Villaboard™ Lining	Hardie™ Mineral	60/60/60	45	Page 49	

60 minute fire rated system

System #	Description	Insulation	FRR	STC	Page
JHETVR60-N	Non-combustible/limited combustible cladding complying with C/AS1 or BPS RAB™ Board Villaboard™ Lining 6mm or 9mm	Hardie™ Mineral	60/60/60	55*	50

*STC value for IT wall

120 minute fire rated system

System #	Description	Insulation	FRR	STC	Page
JHETVR120-N	Villaboard™ Lining 9mm RAB™ Board 9mm Non-combustible/limited combustible cladding complying with C/AS1 or BPS	2 x layers Hardie™ Mineral	120/120/120	56	51

3.2 External Walls - Steel Frame

30 minute fire rated system

System #	Description	Insulation	FRR	STC	Page
JHESGR30-N	Non-combustible/limited combustible cladding complying with C/AS1 or BPS RAB™ Board over thermal fire batten 2 x layers 10mm GIB Fyrelite®	Hardie™ Mineral	30/30/30	47	53

60 minute fire rated system

System #	Description	Insulation	FRR	STC	Page
JHESGR60-N	Non-combustible/limited combustible cladding complying with C/AS1 or BPS RAB™ Board over thermal fire batten 2 x layers 13mm GIB Fyrelite®	Hardie™ Mineral	60/60/60	48	54

3.3 Parapet & Wing Walls - Timber Frame

60 minute fire rated system					
System #	Description	Insulation	FRR	Under 10m	Over 10m or EH/SED Wind Zone
JHETLL60	Linea™ Weatherboard each side	Hardie™ Mineral	60/60/60	Page 56	Page 57
JHETOO60h	Oblique™ Weatherboard horizontal each side	Hardie™ Mineral	60/60/60	Page 58	Page 59
JHETOO60v	Oblique™ Weatherboard vertical each side	Hardie™ Mineral	60/60/60	Page 60	Page 61
JHETWW60	Hardie™ Plank Weatherboard each side	Hardie™ Mineral	60/60/60	Page 62	
JHETSS60h	Stria™ Cladding horizontal each side	Hardie™ Mineral	60/60/60	Page 63	Page 64 Smooth finish only
JHETSS60v	Stria™ Cladding vertical each side	Hardie™ Mineral	60/60/60	Page 65	Page 66 Smooth finish only
JHETFF60	Hardie™ Flex Sheet each side	Hardie™ Mineral	60/60/60	Page 67	
JHETAA60	Axon™ Panel each side	Hardie™ Mineral	60/60/60	Page 68	Page 69
JHETRR60-A	Axon™ Panel - Hardie™ CLD™ Structural Cavity Battens each side RAB™ Board each side	Hardie™ Mineral	60/60/60	Page 70	
JHETRR60-X	ExoTec™ Facade Panel Top Hat System each side RAB™ Board each side	Hardie™ Mineral	60/60/60	Page 71	
JHETRR60-N	Non-combustible/limited combustible cladding complying with C/AS1 or BPS each side RAB™ Board each side	Hardie™ Mineral	60/60/60	Page 72	

Cladding options for Parapet & Wing Walls

Claddings specified in the fire rated systems under Section 3.3 on timber cavity battens can be replaced with any Hardie™ fibre cement cladding 6mm or thicker.

3.4 Internal Walls - Timber Frame

30 minute fire rated system					
System #	Description	Insulation	FRR	STC	Page
JHITGV30	Villaboard™ Lining 6 or 9mm 10mm GIB Fyrelite®	R2.2 glass wool	30/30/30	39	74

60 minute fire rated system					
System #	Description	Insulation	FRR	STC	Page
JHITGV60	Villaboard™ Lining 6 or 9mm 13mm GIB Fyrelite®	Hardie™ Mineral	60/60/60	42	75
JHITV60	Villaboard™ Lining 6 or 9mm each face	Hardie™ Mineral	60/60/60	55*	76
JHITVR60	Villaboard™ Lining 6 or 9mm RAB™ Board 6 or 9mm	Hardie™ Mineral	60/60/60	55*	77

*STC value for IT wall

3.5 Internal Floors / Ceilings - Timber Frame

60 minute fire rated system					
System #	Description	FRR	STC	IIC	Page
JHFTGSS60	2 x layers Secura™ Flooring 2 x layers 13mm GIB Fyrelite® GIB Quiet Clip®	60/60/60	67	57	79

4 Design guidelines

To achieve the performance levels as described in each system, all materials as specified in the system must be used. The basic information regarding the materials to be used can be found in the individual system specification. Refer to James Hardie's product technical specification/installation manuals for further information about their installation.

4.1 Boundary Wall – Post Fire Structural Stability

To ensure compliance with the New Zealand Building Code (NZBC), post fire structural stability requirements vary depending on the design methodology used:

Buildings Designed to NZS 3604

For buildings within the scope of NZS 3604, which is recognised as an Acceptable Solution under Clause 2.3.1 of B1/AS1, post fire structural stability of fire rated walls is deemed to comply with the requirements of Clause 1.1.3 of B1/AS1.

Buildings Outside NZS 3604 or Designed Using Specific Engineering Design (SED)

For buildings outside the scope of NZS 3604, or where Specific Engineering Design (SED) is applied, fire rated walls must demonstrate post fire structural stability in accordance with Paragraph 2.2.1.2 (b) (iii) of B1/VM1.

James Hardie has developed solutions that can be used to meet post fire stability requirements in conjunction with our fire rated systems when required. These solutions are suitable for both concrete and timber foundations. The wall bottom plate can be securely anchored using either Pryda® Brace Anchors or GIB HandiBrac® fixings, installed on both sides of the stud. Refer to Figures 2 to 5 in this manual for detailed installation guidance.

Alternatively, the project structural engineer may develop a project specific post fire stability solution to demonstrate compliance with B1/VM1.

Intertenancy Walls

For dual frame intertenancy wall systems, structural stability is achieved through the installation of GIB® Quiet Ties®, which connect the adjacent wall frames.

Steel Framed Walls

Post fire structural stability for steel framed wall systems must be verified through Specific Engineering Design (SED).

4.2 Acoustic Performance

James Hardie's fire and acoustic systems are suitable to achieve reliable acoustic ratings. The STC ratings published in this manual are specific to the wall build-up as described within each FRR system. To achieve higher acoustic ratings, Ask James Hardie™ on 0800 808 868.

STC means Sound Transmission Class and describes a partition's ability to control airborne noise. Clause G6 of the NZBC requires minimum STC 55 for intertenancy walls

IIC means Impact Insulation Class and describes a floor's ability to control footfall noise. Clause G6 of the NZBC requires minimum IIC 55 for intertenancy floors

Secura™ Flooring is commonly used in floors by acoustic engineers for an STC/IIC rating. The sound attenuation performance of ceilings is measured in STC.

Where the acoustic performance of a wall system is crucial to meet the requirements of Clause G6 of the NZBC, then any penetration or wall junction etc. must be sealed with an acoustic/fire rated sealant.

4.3 Framing

The frame sizes and their spacing stated in this manual are a minimum requirement. Bigger framing sections required to suit a proprietary cladding system, or to suit higher wind pressures or higher loading, does not affect the FRR published.

4.4 Timber

Timber framing must either be in accordance with the NZS 3604 or in accordance with SED. The stud, nogs/dwangs and floor joist spacing, timber size must meet the following minimum requirements:

For walls:

- Framing size 90 x 45mm minimum
- Stud spacing 600mm maximum
- Nogs/dwangs spacing 800mm maximum
- For post fire stability design, framing size and hold down anchors, refer to the construction details

Note: Stud spacings less than 600mm will have a detrimental effect on STC rating

For floors:

- Minimum 45mm wide floor joists shall be used
- Strutting of floor joists is required as per the NZS 3604
- Bottom plate fixing in timber floors must penetrate through floor into joists or solid blocking
- Secura™ Flooring systems are suitable for 3kPa floor loads

4.5 Steel

Steel framing for fire rated walls must be in accordance with the NASH standard for residential and low rise buildings. The framing shall also meet the following requirements:

- Steel sections shall have a base metal thickness (BMT) of 0.55mm minimum for non-load bearing walls and 0.75-1.6mm for load bearing walls
- Steel stud for use in external walls shall be 89mm deep x 39mm wide minimum
- Stud spacing 400mm centres maximum for load bearing walls
- Nogs/dwangs spacing 800mm centres maximum

4.6 Thermal Fire Batten

Fire battens are used on all FRR steel systems and must be used between Hardie™ fibre cement cladding and steel framing members. For steel framing in interior/exterior applications the NZBC also requires additional external insulation to achieve adequate thermal resistance. These insulated battens are assembled on site by cutting a 100mm wide strip from 9mm thick Axon™ Panel Smooth and adhering a 10mm thick x 100mm wide XPS (extruded polystyrene) on its face.

All fire battens are fixed horizontally and vertically to all steel members. All battens must be neatly cut and tightly fitted covering all steel members. All thermal fire battens must be fitted with the polystyrene to the exterior face. The batten is tacked to the steel framing as shown in the following detail.

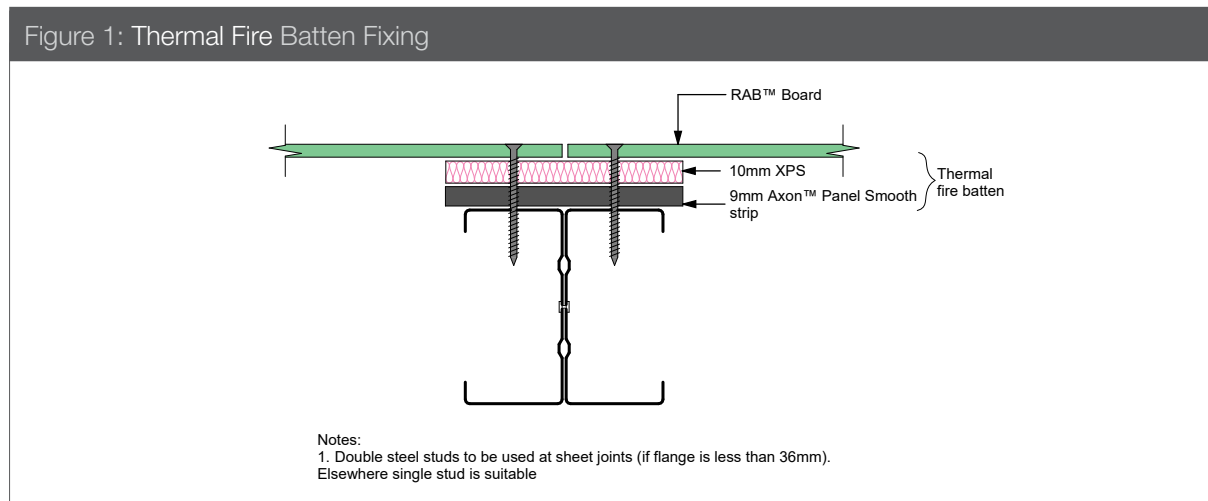

4.7 Structural Steel Members

When structural steel members are located inside the fire rated wall cavity such as columns, or beams in a floor/ceiling cavity, these structural members must be independently fire rated.

4.8 Insulation

4.8.1 Hardie™ Mineral Insulation

Hardie™ Mineral Insulation is used in James Hardie's fire rated systems in accordance with the system specification. Hardie™ Mineral Insulation has been tested with James Hardie's fire rated systems and cannot be substituted with any other insulation material.

Also refer to clause H1 of the NZBC for further information on construction R-value requirements.

Hardie™ Mineral Insulation has the following properties:

- Size: 600 x 800 x 90mm - 2.4m² per bale
- R-Value: 2.74m²K/W
- Density: 80kg/m³

Fit the Hardie™ Mineral Insulation tightly in all framing cavities. Hardie™ Mineral Insulation is pre-cut 50mm bigger in length and width than the cavity size to ensure a tight friction fit in the cavity. If the cavity to be insulated is smaller than the size of insulation supplied, the insulation may be cut on site to fit to size. Ensure that insulation is at least 50mm bigger in each direction than the size of frame cavity to be filled so that a tight friction fit is achieved.

4.8.2 GLASS WOOL Insulation

Where R2.2 glass wool insulation is specified in a system, any brand of R2.2 glass wool insulation which weighs 11–18kg/m³ may be used. A higher R-value glass wool insulation can be used to achieve higher insulation requirements.

4.9 Flexible Underlay

In a FRR system, any flexible underlay that complies with Table C.2.1.1 of E2/AS1 and has a Flammability Index not exceeding 5, when tested to AS 1530.2 may be used.

For inter-tenancy walls up to 10m some fire rated systems can use a flexible underlay. Building height over 10m must use RAB™ Board.

4.10 RAB™ Board

RAB™ Board by James Hardie can be used to achieve fire ratings up to 120 minutes. Flexible underlay is not required when using RAB™ Board.

For building heights over 10m or in EH/SED wind zone, RAB™ Board must be used to meet vertical fire spread and weathertightness performance requirements.

4.11 Cavity Construction

The fire ratings are not affected when the Hardie™ fibre cement cladding is fixed using a timber cavity batten (18-25mm) construction method. Follow the cavity construction specification developed for each cladding material supplied by James Hardie.

4.12 Control Joints

The cladding must be separated at the vertical joint between claddings at tenancy junctions. Refer to Figures 16 and 17. Also refer to Online Figure 1 in the CAD Library on www.jameshardie.co.nz.

4.13 Coatings and Finishes

All Hardie™ fibre cement cladding systems require protective coatings to meet the NZBC requirements. Refer to relevant technical literature by James Hardie for the product selected. All claddings must be maintained in accordance with product literature. Also refer to coating manufacturer's recommendations.

For FRR systems with surface finishes over 1mm thick, designers must ensure that the finishes comply with the requirements of Section 5.3 clause C/AS1 and Section 5.5 clause C/AS2 of the NZBC.

4.14 Bracing

The bracing systems specified in the Bracing Design Manual by James Hardie can be combined with the fire and acoustic systems by adhering to the details outlined for the relevant bracing and fire and acoustic systems.

When fire rated systems are combined with bracing systems then the durability of the components used in the system must meet a 50 years durability requirement of Clause B2 of the NZBC.

Bracing cannot be achieved when Hardie™ fibre cement cladding and pre-cladding products are fixed with screws or when steel framing is used.

4.15 Fire Resistance Rating

Working through C/AS1 and C/AS2 of the NZBC will determine the fire resistance rating required for walls that separates the fire cells. These ratings are expressed as Fire Resistance Rating (FRR) in minutes. Fire engineers may also come up with the fire ratings required for their projects as per their SED.

As an example, if the project requires a wall to achieve a FRR of 60/60/60 (i.e. Stability/Integrity/Insulation) the wall will have the following characteristics:

- The first 60 figure describes the wall's structural stability requirement for 60 minutes. Within this period the wall must support the structure and other fire rated elements within the same or other fire cells. A dash here indicates the wall is not a structural wall (this is typical for non-load bearing systems such as partition walls).
- The second 60 figure describes the wall's integrity requirement for 60 minutes. During this period the hot gases or flames can not pass through the wall to either side. After this period a failure has occurred as the wall system under test develops cracks or openings through which hot gases and smoke can pass.
- The third 60 figure describes the wall's insulation requirement for 60 minutes. After this period a failure has occurred in the wall system under test, when:
 - a) the average temperature of the unexposed surface of the test specimen increases by more than 140°C above the initial temperature, or
 - b) the temperature at any point on the unexposed surface increases by more than 180°C above the initial temperature.

In order to achieve the required fire resistance ratings, James Hardie New Zealand Ltd has developed various fire rated systems starting from 30 minute fire rating up to 120 minute fire rating and these systems are published in this design manual.

These systems have been developed based on various fire tests carried out by James Hardie at BRANZ as per the AS/NZS 1530.4. i.e., stop at end as is new sentence starting. The fire engineers when working on their SED projects, may have some questions regarding the fire testing of a James Hardie system. For any clarifications in this matter, Ask James Hardie™ on 0800 808 868.

4.16 Internal Linings Group Numbers

The internal lining materials are required to be tested as per ISO 9705 or ISO 5660 in order to identify their 'Group Number.'

All Hardie™ fibre cement interior linings have been tested/assessed by BRANZ and they have a '**Group Number 1-S**'. Note that this classification only applies to Hardie™ fibre cement lining products without paint or wet finish. Contact the surface finishes supplier for Group Number information about their finishing products.

Our pre-finished linings Hardie™ Glaze Lining and Invibe™ Panel have also been tested/assessed and they have a '**Group Number 1-S**'. This means Hardie™ fibre cement interior lining products are suitable for use as internal linings in exitways and all occupied spaces in schools, hospitals, detention centres, offices, hotels, motels and apartments type buildings etc.

'Group Number 1-S' is the highest performance expectation as per BPS Section 8.5.

4.17 Control Of External Fire Spread

Safety requirements for external fire spread protection are:

As per Clause C3.5 of the NZBC, building must be designed and constructed so that fire does not spread more than 3.5m vertically from the fire source over the external cladding of multi-level buildings.

External walls of buildings that are within 1m from the boundary must meet the requirements as per Clause C3.7 of the NZBC.

Refer to Table 5.3.1.1 of Section 5.3 of C/AS1 and Table 8.4.1.2 of BPS for the information about the various external wall cladding material requirements.

Hardie™ fibre cement cladding products have been tested to AS/NZS 3837 and are classified as Type-A cladding material. James Hardie's fire safety systems have either been tested or assessed at BRANZ. The systems are suitable to achieve the vertical or horizontal fire spread safety requirements as mentioned above, when installed as per the system specification and the details published in this design manual.

When using fire rated systems by James Hardie for buildings over 10m in height, RAB™ Board must be used and the external wall cavity must be blocked off at each floor level to prevent fire spread within the cavity. Refer to Figure 18 for the horizontal joint detail for an inter-storey fire separation in conjunction with our fire rated systems and Hardie™ fibre cement cladding products.

For construction details of Hardie™ fibre cement cladding products with RAB™ Board, Ask James Hardie™ on 0800 808 868.

4.18 Product Substitution

The performance of a fire and acoustic system published in this manual will be compromised when a product specified in the system gets substituted. Therefore to ensure the intended performance is achieved, do not substitute the products specified in FRR systems without consultation with James Hardie.

Ask James Hardie™ 0800 808 868 to discuss the suitability of any alternative product.

For substituting a Hardie™ fibre cement product with another Hardie™ fibre cement product in a specified system Ask James Hardie™ 0800 808 868.

4.19 Plasterboard

Plasterboard lining must be fixed and stopped in accordance with the plasterboard manufacturer's recommendations. Regarding the use of GIB® plasterboard lining products, the following substitutions are allowed.

Acceptable GIB Fyreline® alternatives	
10mm GIB Fyreline® can be replaced with	10mm GIB Braceline®/Noiseline® 10mm GIB Ultraline® 10mm GIB Aqualine® 13mm GIB® Standard
13mm GIB Fyreline® can be replaced with	13mm GIB Braceline®/Noiseline® 13mm GIB Aqualine® 13mm GIB Toughline® 13mm GIB Toughline® Aqua

Other plasterboard suppliers e.g. Elephant Plasterboard® have also developed various fire rated systems in conjunction with Hardie™ fibre cement cladding products. Refer to these plasterboard manufacturer's for information on their fire rated systems.

External Walls Timber Frame

30 Minute Fire Rated System

60 Minute Fire Rated System

120 Minute Fire Rated System

Cladding	Linea™ Weatherboard	Lining	10mm GIB Fyreline®
Framing	Timber framing to be in accordance with NZS 3604 or SED complying with AS/NZS 1170 and NZS 3603. Framing size 90 x 45mm minimum. Studs at 600mm centres and nogs at 800mm centres maximum	Insulation	Glass wool insulation 90mm thick, R2.2 or higher.
Cavity Batten	Timber cavity batten nominal 20mm.	Underlay	A flexible underlay that complies with Table C.2.1.1 of E2/AS1 and has a 'flammability index' not exceeding 5 can be used
Cladding Fixing	<p>Direct Fix: Face fixed with 60 x 2.87mm jolt head nails to studs</p> <p>Cavity Fix: Face fixed with 75 x 3.15mm jolt head nails to studs</p>	Lining Fixing	<p>Fix GIB Fyreline® with 41mm x 6g GIB® Grabber® High Thread Drywall Screws</p> <p>300mm centre around the sheet perimeter and intermediate studs</p> <p>Fixing to be 12mm from bound sheet edges and 18mm from sheet ends</p>

For further information refer to Linea™ Weatherboard Cavity Fix Or Direct Fix Technical Specification.

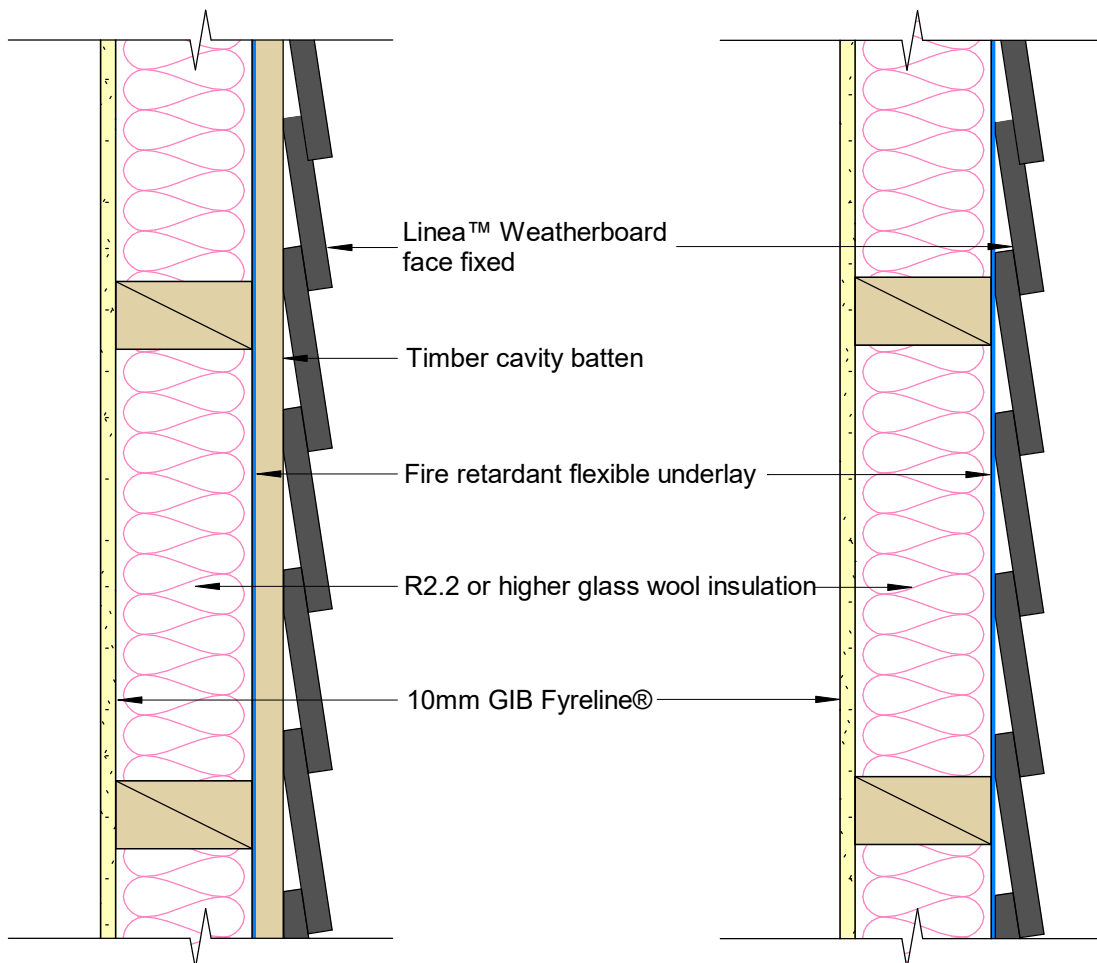

Cladding	Oblique™ Weatherboard - Horizontal	Lining	10mm GIB Fyreline®
Framing	Timber framing to be in accordance with NZS 3604 or SED complying with AS/NZS 1170 and NZS 3603. Framing size 90 x 45mm minimum. Studs at 600mm centres and nogs at 800mm centres maximum	Insulation	Glass wool insulation 90mm thick, R2.2 or higher.
Cavity Batten	Timber cavity batten nominal 20mm	Underlay	A flexible underlay that complies with Table C.2.1.1 of E2/AS1 and has a 'flammability index' not exceeding 5 can be used
Cladding Fixing	<p>200mm wide weatherboard: 65 x 2.87mm D-Head or round head nail to stud</p> <p>300mm wide weatherboard: Two nails per stud, 65 x 2.87mm D-Head or round head nail</p>	Lining Fixing	<p>Fix GIB Fyreline® with 41mm x 6g GIB® Grabber® High Thread Drywall Screws</p> <p>300mm centre around the sheet perimeter and intermediate studs</p> <p>Fixing to be 12mm from bound sheet edges and 18mm from sheet ends</p>

For further information refer to Oblique™ Weatherboard Horizontal Installation Technical Specification.

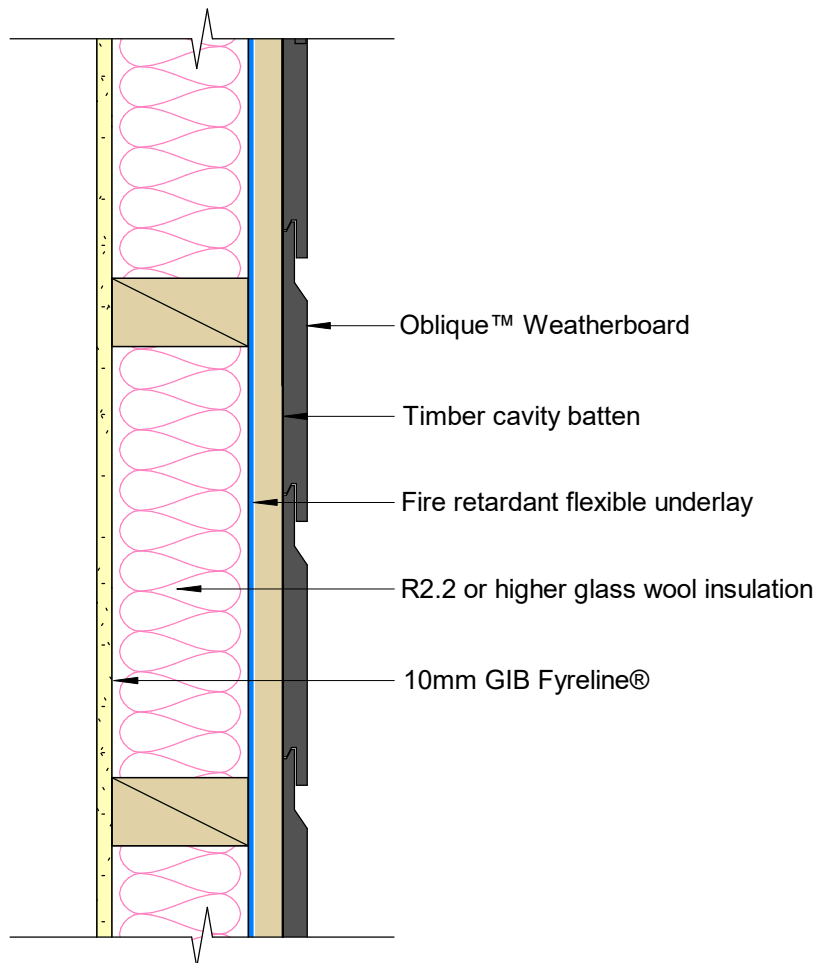

Cladding	Oblique™ Weatherboard - Vertical	Lining	10mm GIB Fyreline®
Framing	Timber framing to be in accordance with NZS 3604 or SED complying with AS/NZS 1170 and NZS 3603. Framing size 90 x 45mm minimum. Studs at 600mm centres and nogs at 800mm centres maximum	Insulation	Glass wool insulation 90mm thick, R2.2 or higher.
Cavity Batten	Hardie™ horizontal timber cavity batten 20mm	Underlay	A flexible underlay that complies with Table C.2.1.1 of E2/AS1 and has a 'flammability index' not exceeding 5 can be used
Cladding Fixing	200mm wide weatherboard: 65 x 2.87mm D-Head or round head nail to nog 300mm wide weatherboard: Two nails per nog, 65 x 2.87mm D-Head or round head nail	Lining Fixing	Fix GIB Fyreline® with 41mm x 6g GIB® Grabber® High Thread Drywall Screws 300mm centre around the sheet perimeter and intermediate studs Fixing to be 12mm from bound sheet edges and 18mm from sheet ends

For further information refer to Oblique™ Weatherboard Vertical Installation Technical Specification.

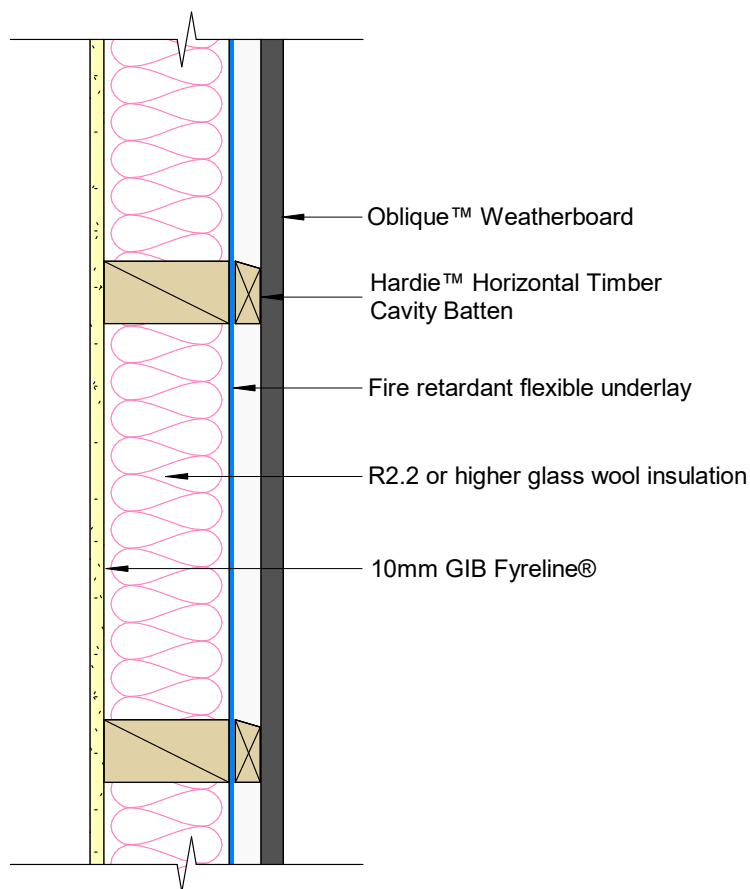

Cladding	Hardie™ Plank Weatherboard	Lining	10mm GIB Fyrelite®
Framing	Timber framing to be in accordance with NZS 3604 or SED complying with AS/NZS 1170 and NZS 3603. Framing size 90 x 45mm minimum. Studs at 600mm centres and nogs at 800mm centres maximum	Insulation	Glass wool insulation 90mm thick, R2.2 or higher.
Cavity Batten	Timber cavity batten nominal 20mm	Underlay	A flexible underlay that complies with Table C.2.1.1 of E2/AS1 and has a 'flammability index' not exceeding 5 can be used
Cladding Fixing	<p>Hardie™ Plank Weatherboard 7.5mm</p> <p>Direct Fix: Face fixed with 50 x 2.8mm fibre cement nail to stud</p> <p>Cavity Fix: Face fixed with 75 x 3.15mm fibre cement nail to stud</p> <p>Hardie™ Plank Weatherboard 10mm</p> <p>Direct Fix: Conceal fix with 50 x 2.8mm fibre cement nail to stud. Face fix internal corners 60 x 3.05mm jolt head</p> <p>Cavity Fix: Flexible underlay - conceal fix with 60 x 2.8mm fibre cement nail to stud. Face fix internal corners 75 x 3.15mm jolt head</p> <p>Cavity Fix: RAB™ Board - conceal fix with 75 x 2.8mm fibre cement nail to stud. Face fix internal corners 75 x 3.15mm jolt head</p>	Lining Fixing	<p>Fix GIB Fyrelite® with 41mm x 6g GIB® Grabber® High Thread Drywall Screws</p> <p>300mm centre around the sheet perimeter and intermediate studs</p> <p>Fixing to be 12mm from bound sheet edges and 18mm from sheet ends</p>

For further information refer to Hardie™ Plank Weatherboard 7.5mm Technical Specification. Hardie™ Plank Weatherboard 10mm Technical Specification.

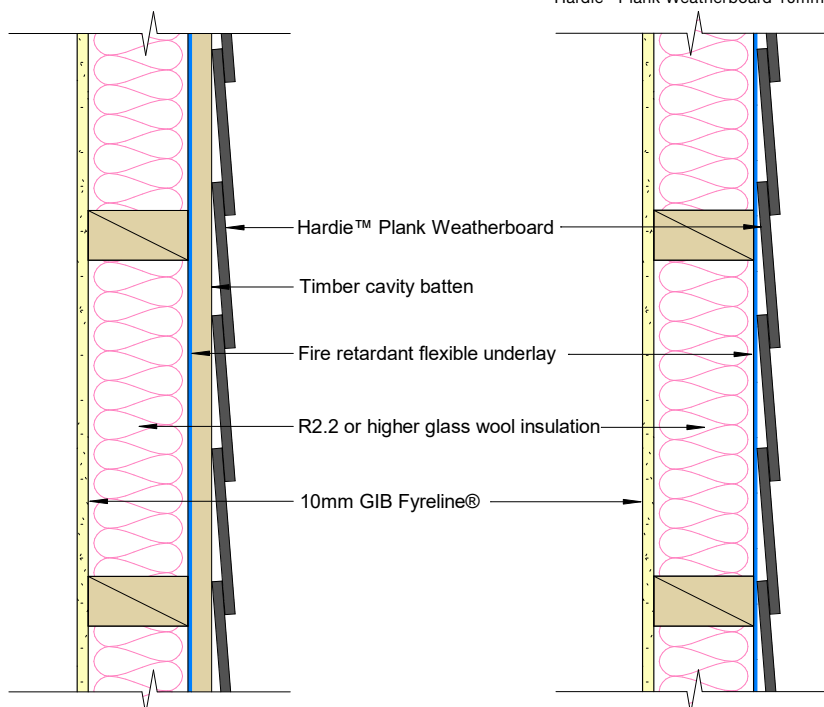

Cladding	Stria™ Cladding - Vertical	Lining	10mm GIB Fyreline®
Framing	Timber framing to be in accordance with NZS 3604 or SED complying with AS/NZS 1170 and NZS 3603. Framing size 90 x 45mm minimum. Studs at 600mm centres and nogs at centres maximum 800mm for Smooth and 600mm for Fine Texture	Insulation	Glass wool insulation 90mm thick, R2.2 or higher.
Cavity Batten	Hardie™ horizontal timber cavity batten 20mm	Underlay	A flexible underlay that complies with Table C.2.1.1 of E2/AS1 and has a 'flammability index' not exceeding 5 can be used
Cladding Fixing	<p>Stria™ Cladding Smooth 65 x 2.87mm D-Head or round head nails to nog</p> <p>Stria™ Cladding Fine Texture 60 x 3.15mm Hardie™ Flex or 65 x 2.87mm round head nails to nog</p>	Lining Fixing	<p>Fix GIB Fyreline® with 41mm x 6g GIB® Grabber® High Thread Drywall Screws 300mm centre around the sheet perimeter and intermediate studs</p> <p>Fixing to be 12mm from bound sheet edges and 18mm from sheet ends</p>

For further information refer to Stria™ Cladding Smooth Vertical Installation Technical Specification.
Stria™ Cladding Fine Texture Vertical Installation Technical Specification.

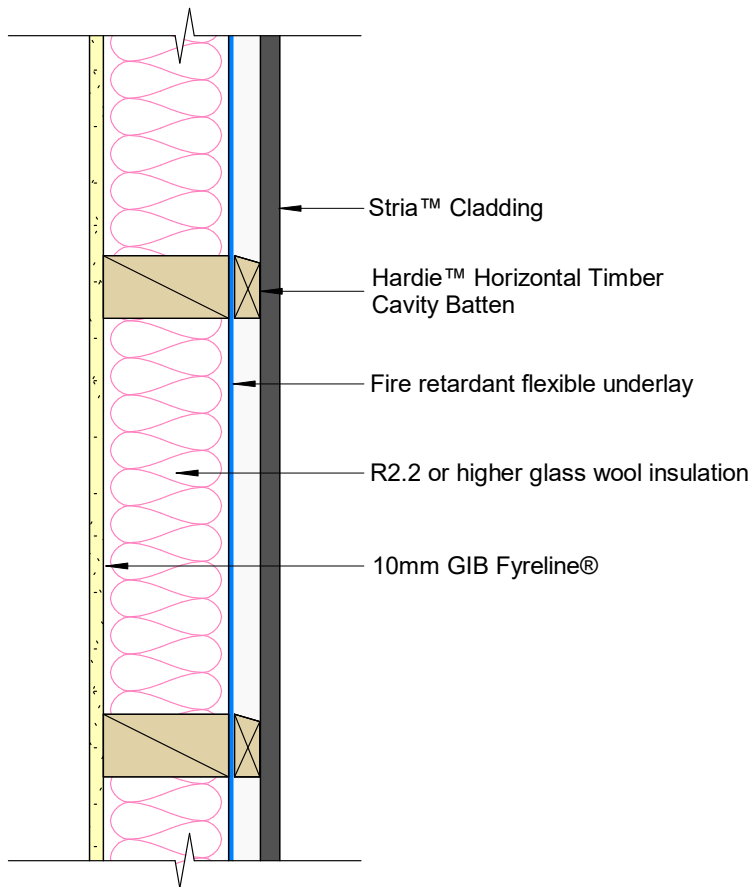

Cladding	Hardie™ Flex Sheet	Lining	10mm GIB Fyreline®
Framing	Timber framing to be in accordance with NZS 3604 or SED complying with AS/NZS 1170 and NZS 3603. Framing size 90 x 45mm minimum. Studs at 600mm centres and nogs at 800mm centres maximum	Insulation	Glass wool insulation 90mm thick, R2.2 or higher.
Cavity Batten	Timber cavity batten nominal 20mm	Underlay	A flexible underlay that complies with Table C.2.1.1 of E2/AS1 and has a 'flammability index' not exceeding 5 can be used
Cladding Fixing	Direct Fix: 40 x 2.8mm fibre cement nail at 150mm centres to entire frame Cavity Fix: 60 x 3.15mm fibre cement nail at 150mm centres to entire frame	Lining Fixing	Fix GIB Fyreline® with 41mm x 6g GIB® Grabber® High Thread Drywall Screws 300mm centre around the sheet perimeter and intermediate studs Fixing to be 12mm from bound sheet edges and 18mm from sheet ends

For further information refer to Hardie™ Flex Sheet Technical Specification.

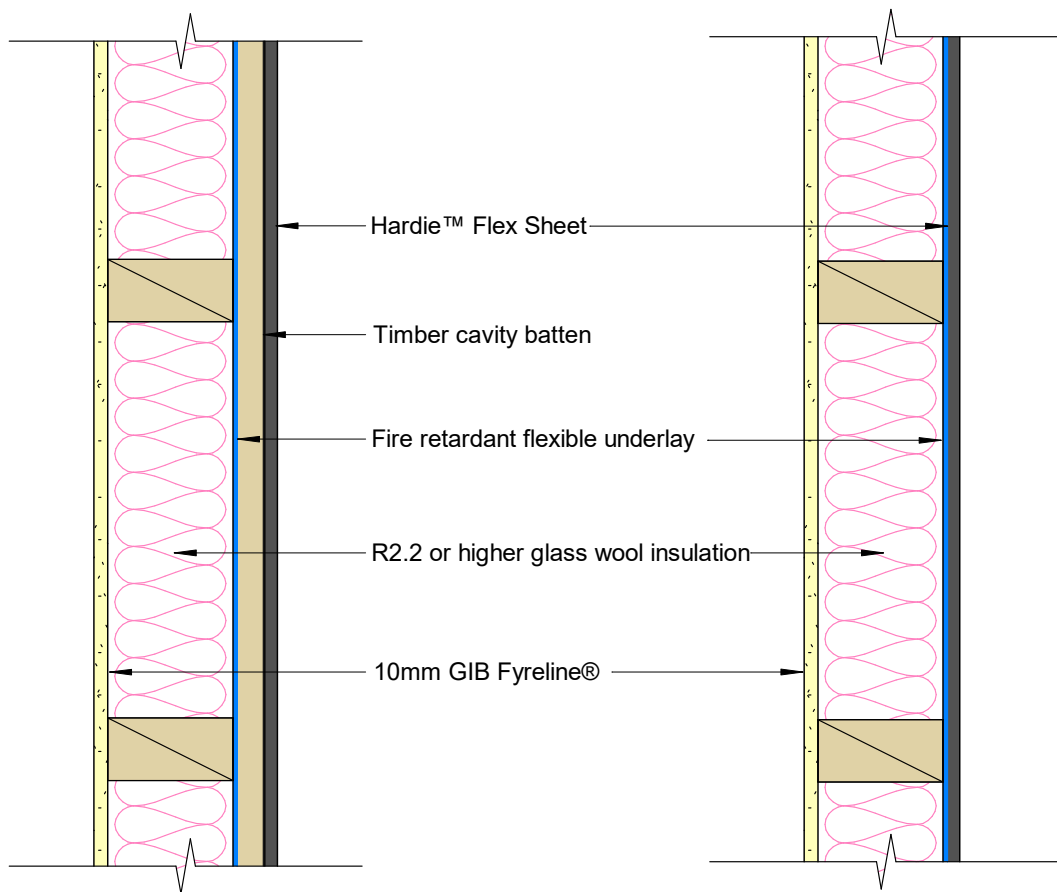

Cladding	Axon™ Panel	Lining	10mm GIB Fyreline®
Framing	Timber framing to be in accordance with NZS 3604 or SED complying with AS/NZS 1170 and NZS 3603. Framing size 90 x 45mm minimum. Studs at 600mm centres and nogs at 800mm centres maximum	Insulation	Glass wool insulation 90mm thick, R2.2 or higher.
Cavity Batten	Timber cavity batten nominal 20mm	Underlay	A flexible underlay that complies with Table C.2.1.1 of E2/AS1 and has a 'flammability index' not exceeding 5 can be used
Cladding Fixing	Direct Fix: 40 x 2.8mm round head nail at 150mm centres to entire frame Cavity Fix: 60 x 3.15mm round head nail at 150mm centres to entire frame	Lining Fixing	Fix GIB Fyreline® with 41mm x 6g GIB® Grabber® High Thread Drywall Screws 300mm centre around the sheet perimeter and intermediate studs Fixing to be 12mm from bound sheet edges and 18mm from sheet ends

For further information refer to Axon™ Panel Timber Cavity Batten or Direct Fix Technical Specification

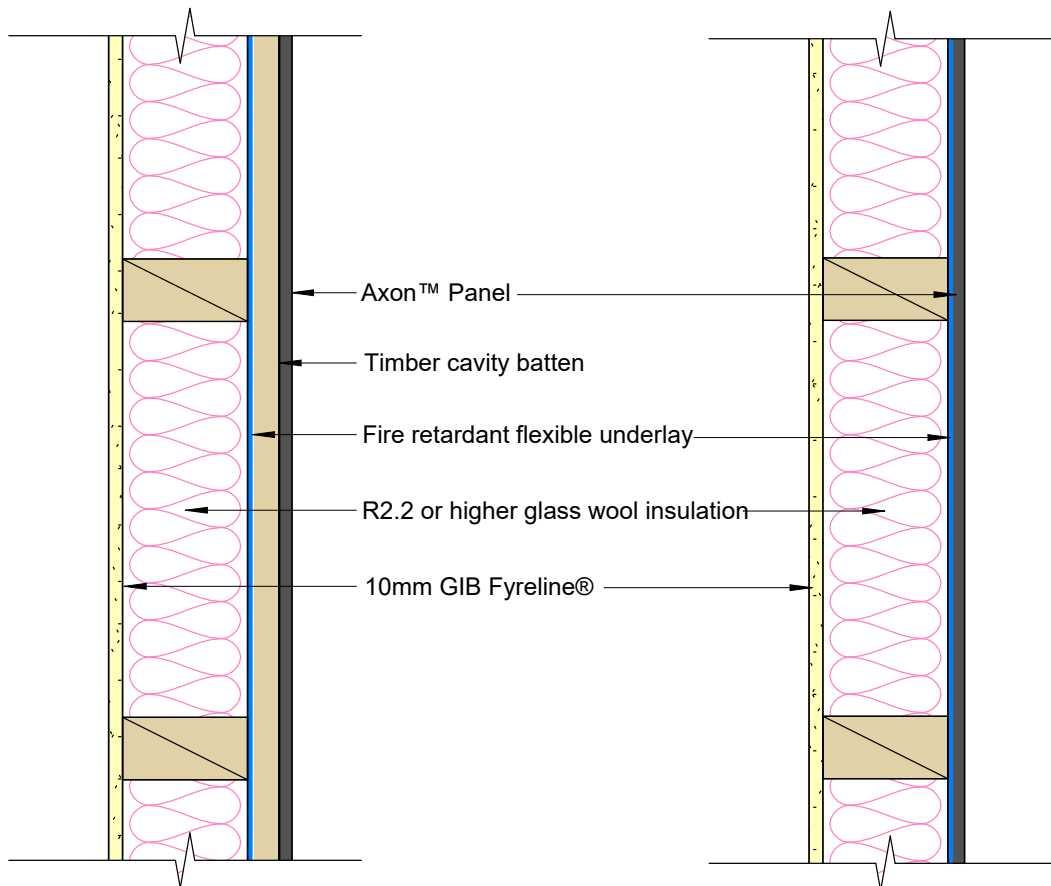

Cladding	Axon™ Panel	Lining	10mm GIB Fyrelite®
Framing	Timber framing to be in accordance with NZS 3604 or SED complying with AS/NZS 1170 and NZS 3603. Framing size 90 x 45mm minimum. Studs at 600mm centres and nogs at 800mm centres maximum.	Insulation	Glass wool insulation 90mm thick, R2.2 or higher.
Cavity Batten	70 x 19mm Hardie™ CLD™ Structural Cavity Batten	Underlay	RAB™ Board
Cladding Fixing	As per Axon™ Panel Fixed to Hardie™ CLD™ Structural Cavity Batten Technical Specification	Lining Fixing	Fix GIB Fyrelite® with 41mm x 6g GIB® Grabber® High Thread Drywall Screws 300mm centre around the sheet perimeter and intermediate studs Fixing to be 12mm from bound sheet edges and 18mm from sheet ends
RAB™ Board Fixing	RAB™ Board 6mm: 40 x 2.8mm fibre cement nail at 150mm centres to entire framing RAB™ Board 9mm: 50 x 2.8mm fibre cement nail at 150mm centres to entire framing Fixing to be 12mm from sheet edges		

No cladding required for wall applications enclosed within the roof space.
For further information refer to HomeRAB™ Pre-Cladding and RAB™ Board Installation Manual.

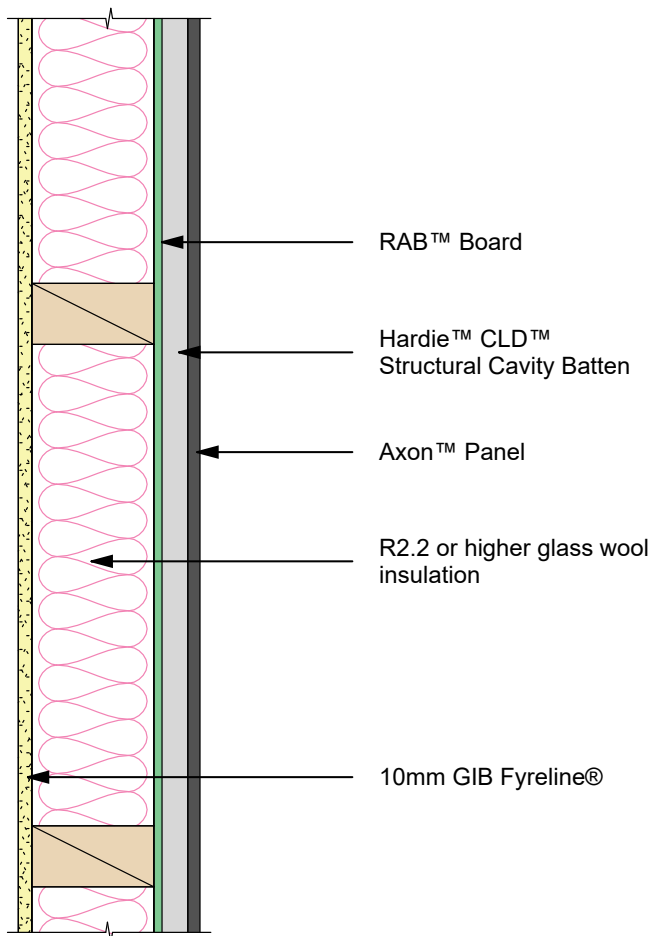

Cladding	ExoTec™ Facade Panel	Lining	10mm GIB Fyreline®
Framing	Timber framing to be in accordance with NZS 3604 or SED complying with AS/NZS 1170 and NZS 3603. Framing size 90 x 45mm minimum. Studs at 600mm centres and nogs at 800mm centres maximum.	Insulation	Glass wool insulation 90mm thick, R2.2 or higher
Cavity Batten	ExoTec™ Top Hat System	Underlay	RAB™ Board
Cladding Fixing	As per ExoTec™ Facade Panel Top Hat Technical Specification	Lining Fixing	Fix GIB Fyreline® with 41mm x 6g GIB® Grabber® High Thread Drywall Screws 300mm centre around the sheet perimeter and intermediate studs Fixing to be 12mm from bound sheet edges and 18mm from sheet ends
RAB™ Board Fixing	RAB™ Board 6mm: 40 x 2.8mm fibre cement nail at 150mm centres to entire framing RAB™ Board 9mm: 50 x 2.8mm fibre cement nail at 150mm centres to entire framing Fixing to be 12mm from sheet edges		

No cladding required for wall applications enclosed within the roof space.
For further information refer to HomeRAB™ Pre-Cladding and RAB™ Board Installation Manual.

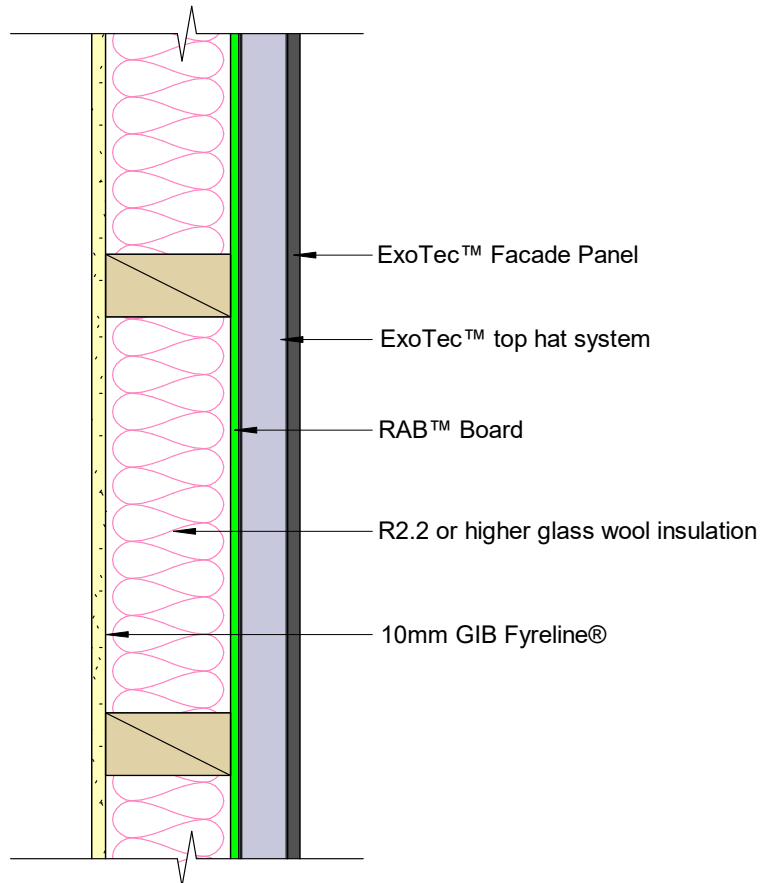

Cladding	Brick to the NZS 4210	Lining	10mm GIB Fyrelite®
Framing	Timber framing to be in accordance with NZS 3604 or SED complying with AS/NZS 1170 and NZS 3603. Framing size 90 x 45mm minimum. Studs at 600mm centres and nogs at 800mm centres maximum	Insulation	Glass wool insulation 90mm thick, R2.2 or higher
Cavity	As per cladding manufacturer technical specification	Underlay	RAB™ Board
Cladding Fixing	As per cladding manufacturer technical specification	Lining Fixing	Fix GIB Fyrelite® with 41mm x 6g GIB® Grabber® High Thread Drywall Screws 300mm centre around the sheet perimeter and intermediate studs Fixing to be 12mm from bound sheet edges and 18mm from sheet ends
RAB™ Board Fixing	RAB™ Board 6mm: 40 x 2.8mm fibre cement nail at 150mm centres to entire framing RAB™ Board 9mm: 50 x 2.8mm fibre cement nail at 150mm centres to entire framing Fixing to be 12mm from sheet edges		

No cladding required for wall applications enclosed within the roof space.
For further information refer to HomeRAB™ Pre-Cladding and RAB™ Board Installation Manual.

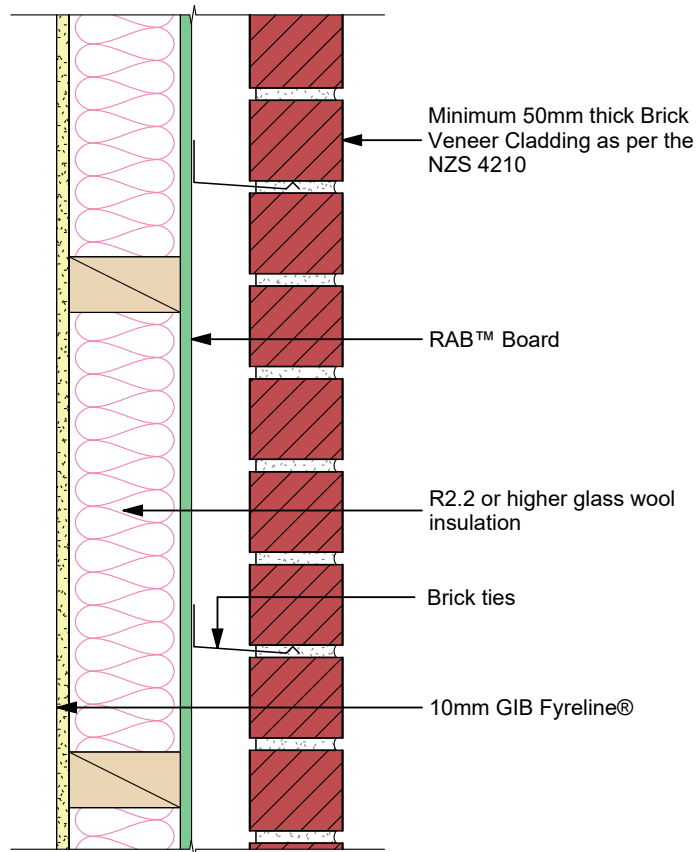

Cladding	Cladding system as per Table 5.3.1.1 of C/AS1 and Table 8.4.1.2 of Building Product Specifications	Lining	10mm GIB Fyrelite®
Framing	Timber framing to be in accordance with NZS 3604 or SED complying with AS/NZS 1170 and NZS 3603. Framing size 90 x 45mm minimum. Studs at 600mm centres and nogs at 800mm centres maximum	Insulation	Glass wool insulation 90mm thick, R2.2 or higher.
Cavity Batten	As per cladding manufacturer technical specification	Underlay	RAB™ Board
Cladding Fixing	As per cladding manufacturer technical specification	Lining Fixing	Fix GIB Fyrelite® with 41 mm x 6g GIB® Grabber® High Thread Drywall Screws 300mm centre around the sheet perimeter and intermediate studs Fixing to be 12mm from bound sheet edges and 18mm from sheet ends
RAB™ Board Fixing	RAB™ Board 6mm: 40 x 2.8mm fibre cement nail at 150mm centres to entire framing RAB™ Board 9mm: 50 x 2.8mm fibre cement nail at 150mm centres to entire framing Fixing to be 12mm from sheet edges		

No cladding required for wall applications enclosed within the roof space.
For further information refer to HomeRAB™ Pre-Cladding and RAB™ Board Installation Manual.

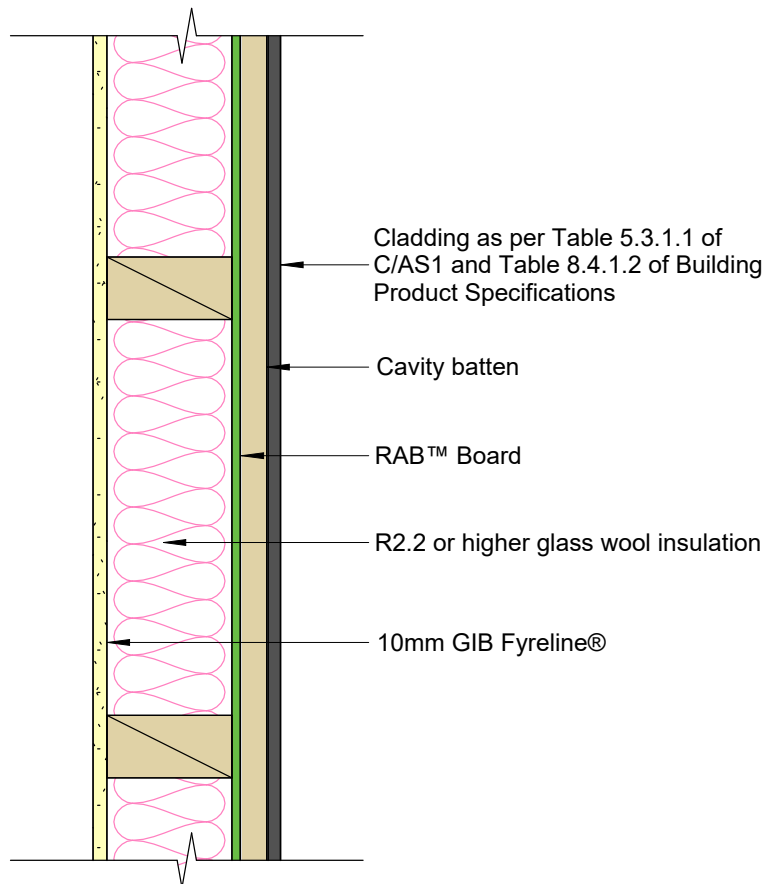

Cladding	Linea™ Weatherboard	Lining	13mm GIB Fyreline®
Framing	Timber framing to be in accordance with NZS 3604 or SED complying with AS/NZS 1170 and NZS 3603. Framing size 90 x 45mm minimum. Studs at 600mm centres and nogs at 800mm centres maximum	Insulation	Glass wool insulation 90mm thick, R2.2 or higher.
Cavity Batten	Timber cavity batten nominal 20mm	Underlay	A flexible underlay that complies with Table C.2.1.1 of E2/AS1 and has a 'flammability index' not exceeding 5 can be used
Cladding Fixing	Direct Fix: Face fixed with 60 x 2.87mm jolt head nails to studs Cavity Fix: Face fixed with 75 x 3.15mm jolt head nails to studs	Lining Fixing	Fix GIB Fyreline® with 41mm x 6g GIB® Grabber® High Thread Drywall Screws 300mm centre around the sheet perimeter and intermediate studs Fixing to be 12mm from bound sheet edges and 18mm from sheet ends

For further information refer to Linea™ Weatherboard Cavity Fix or Direct Fix Technical Specification.

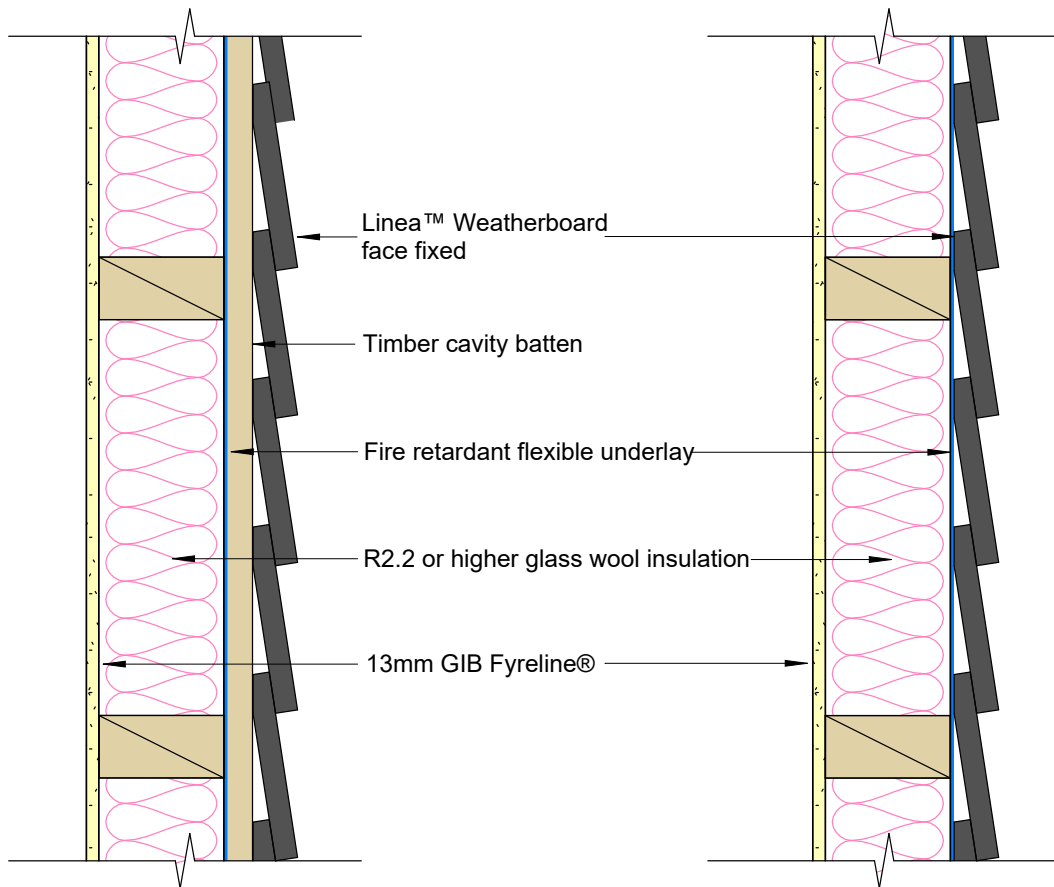

JHETGL60**Fire Resistance** 60/60/60**STC** 45**Over 10m or EH/SED Wind Zone**

Cladding	Linea™ Weatherboard	Lining	13mm GIB Fyreline®
Framing	Timber framing to be in accordance with NZS 3604 or SED complying with AS/NZS 1170 and NZS 3603. Framing size 90 x 45mm minimum. Studs at 600mm centres and nogs at 800mm centres maximum	Insulation	Glass wool insulation 90mm thick, R2.2 or higher.
Cavity Batten	Timber cavity batten nominal 20mm	Underlay	RAB™ Board
Cladding Fixing	Face fixed with 90 x 3.55mm jolt head nails to studs	Lining Fixing	Fix GIB Fyreline® with 41mm x 6g GIB® Grabber® High Thread Drywall Screws 300mm centre around the sheet perimeter and intermediate studs Fixing to be 12mm from bound sheet edges and 18mm from sheet ends
RAB™ Board Fixing	RAB™ Board 6mm: 40 x 2.8mm fibre cement nail at 200mm centres to entire framing RAB™ Board 9mm: 50 x 2.8mm fibre cement nail at 200mm centres to entire framing Fixing to be 12mm from sheet edges		

For further information refer to Linea™ Weatherboard Cavity Fix or Direct Fix Technical Specification.

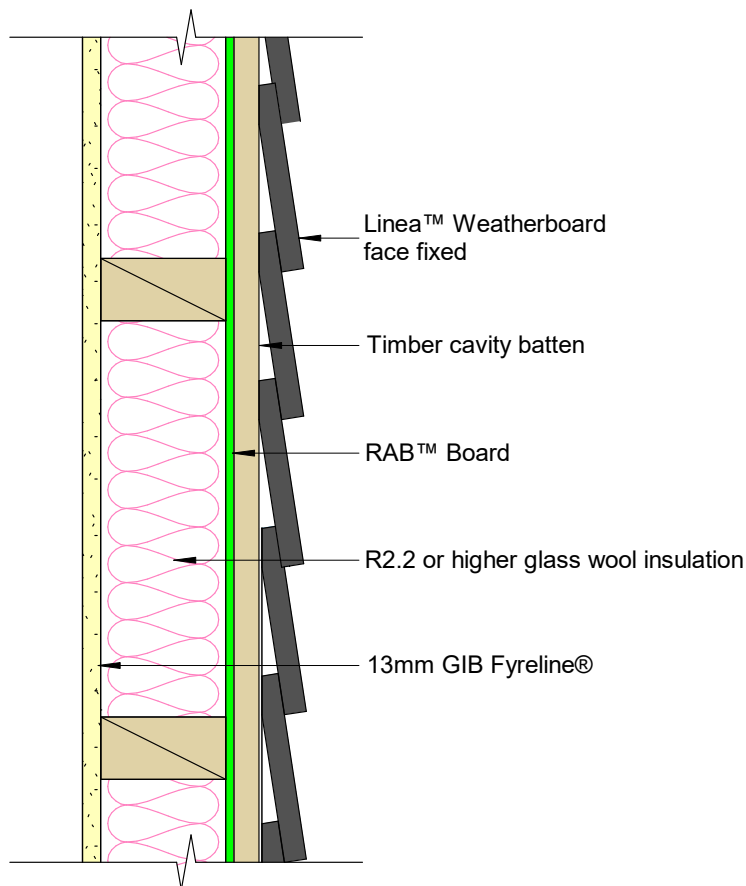

Cladding	Oblique™ Weatherboard - Horizontal	Lining	13mm GIB Fyrelite®
Framing	Timber framing to be in accordance with NZS 3604 or SED complying with AS/NZS 1170 and NZS 3603. Framing size 90 x 45mm minimum. Studs at 600mm centres and nogs at 800mm centres maximum	Insulation	Glass wool insulation 90mm thick, R2.2 or higher.
Cavity Batten	Timber cavity batten nominal 20mm	Underlay	A flexible underlay that complies with Table C.2.1.1 of E2/AS1 and has a 'flammability index' not exceeding 5 can be used
Cladding Fixing	Number/type of nails as per Oblique™ Weatherboard Horizontal Installation Technical Specification	Lining Fixing	Fix GIB Fyrelite® with 41mm x 6g GIB® Grabber® High Thread Drywall Screws 300mm centre around the sheet perimeter and intermediate studs Fixing to be 12mm from bound sheet edges and 18mm from sheet ends

For further information refer to Oblique™ Weatherboard Horizontal Installation Technical Specification.

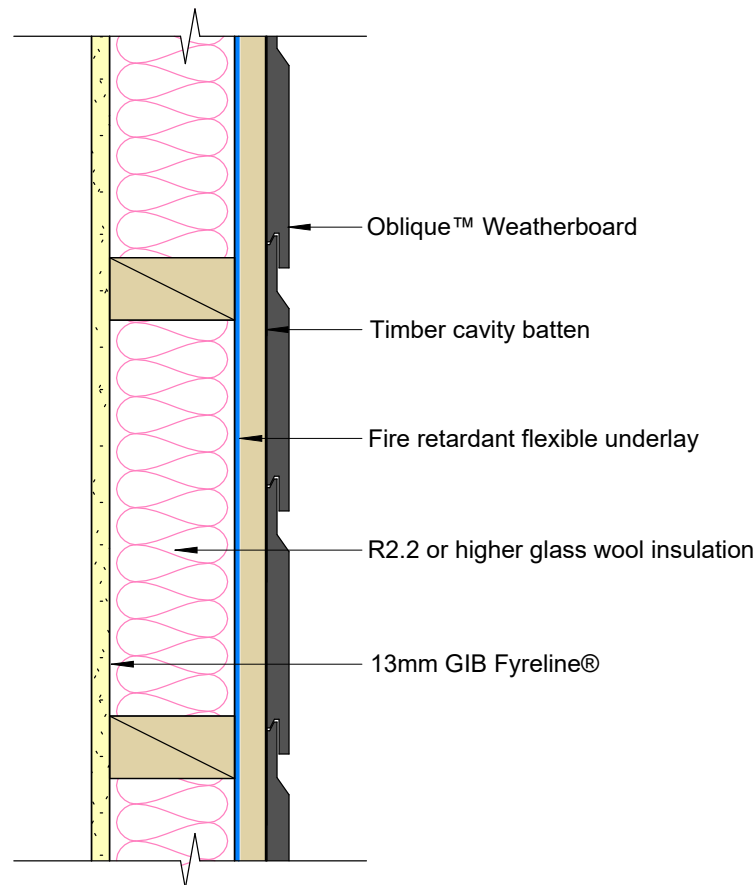

Cladding	Oblique™ Weatherboard - Horizontal	Lining	13mm GIB Fyreline®
Framing	Timber framing to be in accordance with NZS 3604 or SED complying with AS/NZS 1170 and NZS 3603. Framing size 90 x 45mm minimum. Studs at 600mm centres and nogs at 800mm centres maximum	Insulation	Glass wool insulation 90mm thick, R2.2 or higher.
Cavity Batten	Timber cavity batten nominal 20mm	Underlay	RAB™ Board
Cladding Fixing	Number/type of nails as per Oblique™ Weatherboard Horizontal Installation Technical Specification	Lining Fixing	Fix GIB Fyreline® with 41mm x 6g GIB® Grabber® High Thread Drywall Screws 300mm centre around the sheet perimeter and intermediate studs Fixing to be 12mm from bound sheet edges and 18mm from sheet ends
RAB™ Board Fixing	RAB™ Board 6mm: 40 x 2.8mm fibre cement nail at 200mm centres to entire framing RAB™ Board 9mm: 50 x 2.8mm fibre cement nail at 200mm centres to entire framing Fixing to be 12mm from sheet edges		

For further information refer to Oblique™ Weatherboard Horizontal Installation Technical Specification.

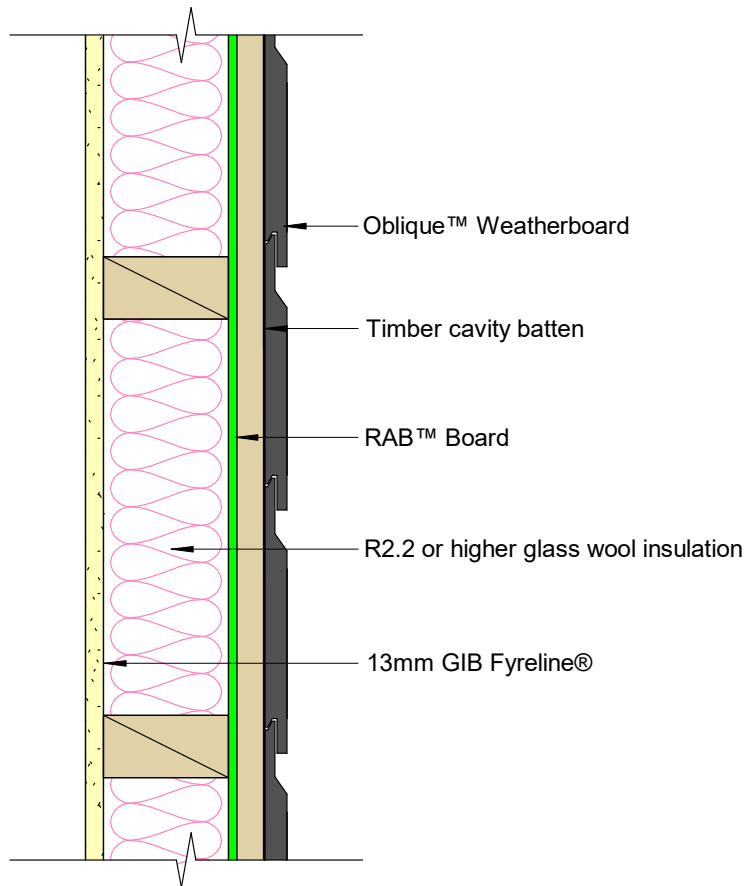

Cladding	Oblique™ Weatherboard - Vertical	Lining	13mm GIB Fyreline®
Framing	Timber framing to be in accordance with NZS 3604 or SED complying with AS/NZS 1170 and NZS 3603. Framing size 90 x 45mm minimum. Studs at 600mm centres and nogs at 800mm centres maximum	Insulation	Glass wool insulation 90mm thick, R2.2 or higher.
Cavity Batten	Hardie™ horizontal timber cavity batten 20mm	Underlay	A flexible underlay that complies with Table C.2.1.1 of E2/AS1 and has a 'flammability index' not exceeding 5 can be used
Cladding Fixing	Number/type of nails as per Oblique™ Weatherboard Vertical Installation Technical Specification	Lining Fixing	Fix GIB Fyreline® with 41mm x 6g GIB® Grabber® High Thread Drywall Screws 300mm centre around the sheet perimeter and intermediate studs Fixing to be 12mm from bound sheet edges and 18mm from sheet ends

For further information refer to Oblique™ Weatherboard Vertical Installation Technical Specification.

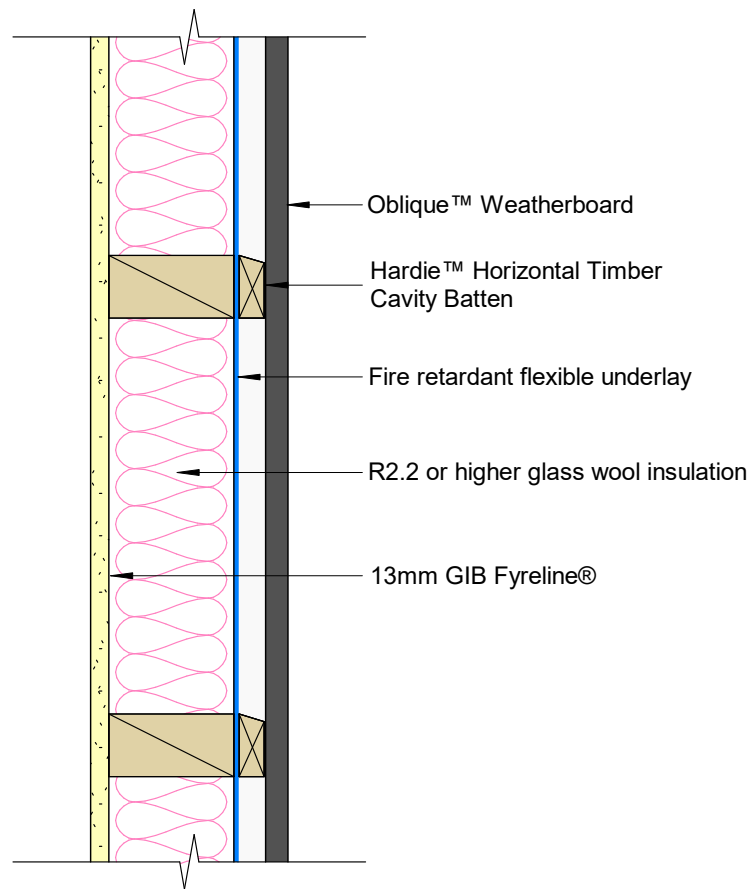

Cladding	Oblique™ Weatherboard - Vertical	Lining	13mm GIB Fyreline®
Framing	Timber framing to be in accordance with NZS 3604 or SED complying with AS/NZS 1170 and NZS 3603. Framing size 90 x 45mm minimum. Studs at 600mm centres and nogs at 800mm centres maximum	Insulation	Glass wool insulation 90mm thick, R2.2 or higher.
Cavity Batten	Hardie™ horizontal timber cavity batten 20mm	Underlay	RAB™ Board
Cladding Fixing	Number/type of nails as per Oblique™ Weatherboard Vertical Installation Technical Specification	Lining Fixing	Fix GIB Fyreline® with 41mm x 6g GIB® Grabber® High Thread Drywall Screws 300mm centre around the sheet perimeter and intermediate studs Fixing to be 12mm from bound sheet edges and 18mm from sheet ends
RAB™ Board Fixing	RAB™ Board 6mm: 40 x 2.8mm fibre cement nail at 200mm centres to entire framing RAB™ Board 9mm: 50 x 2.8mm fibre cement nail at 200mm centres to entire framing Fixing to be 12mm from sheet edges		

For further information refer to Oblique™ Weatherboard Vertical Installation Technical Specification.

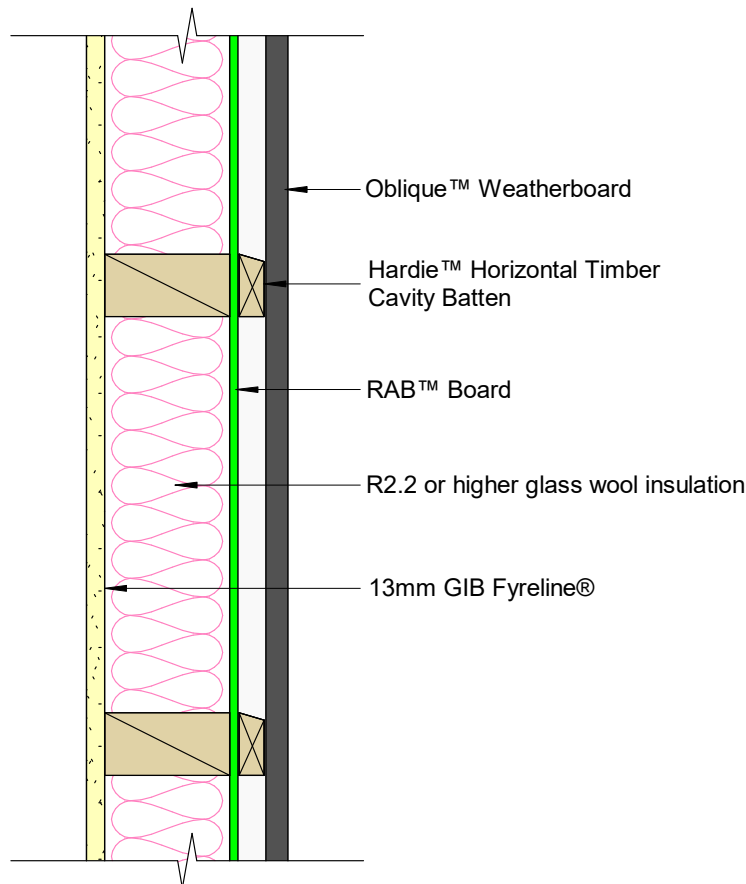

Cladding	Hardie™ Plank Weatherboard	Lining	13mm GIB Fyreline®
Framing	Timber framing to be in accordance with NZS 3604 or SED complying with AS/NZS 1170 and NZS 3603. Framing size 90 x 45mm minimum. Studs at 600mm centres and nogs at 800mm centres maximum	Insulation	Hardie™ Mineral Insulation
Cavity Batten	Timber cavity batten nominal 20mm	Underlay	A flexible underlay that complies with Table C.2.1.1 of E2/AS1 and has a 'flammability index' not exceeding 5 can be used
Cladding Fixing	<p>Hardie™ Plank Weatherboard 7.5mm</p> <p>Direct Fix: 50 x 2.8mm fibre cement nail to stud</p> <p>Cavity Fix: Face fixed with 75 x 3.15mm fibre cement nail to stud</p> <p>Hardie™ Plank Weatherboard 10mm</p> <p>Direct Fix: Conceal fix with 50 x 2.8mm fibre cement nail to stud. Face fix internal corners 60 x 3.05mm jolt head</p> <p>Cavity Fix: Flexible underlay - conceal fix with 60 x 2.8mm fibre cement nail to stud. Face fix internal corners 75 x 3.15mm jolt head.</p> <p>Cavity Fix: RAB™ Board - conceal fix with 75 x 2.8mm fibre cement nail to stud. Face fix internal corners 75 x 3.15mm jolt head.</p>	Lining Fixing	<p>Fix GIB Fyreline® with 41mm x 6g GIB® Grabber® High Thread Drywall Screws</p> <p>300mm centre around the sheet perimeter and intermediate studs</p> <p>Fixing to be 12mm from bound sheet edges and 18mm from sheet ends</p>

For further information refer to Hardie™ Plank Weatherboard 7.5mm Technical Specification. Hardie™ Plank Weatherboard 10mm Technical Specification.

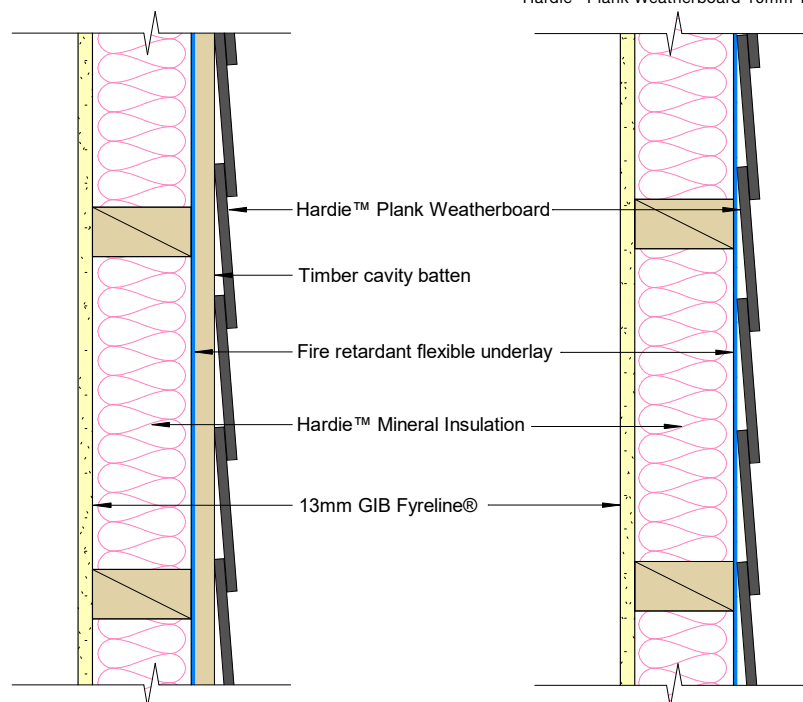

Cladding	Stria™ Cladding Smooth/Fine Texture - Horizontal	Lining	13mm GIB Fyreline®
Framing	Timber framing to be in accordance with NZS 3604 or SED complying with AS/NZS 1170 and NZS 3603. Framing size 90 x 45mm minimum. Studs at 600mm centres and nogs at 800mm centres maximum	Insulation	Glass wool insulation 90mm thick, R2.2 or higher.
Cavity Batten	Timber cavity batten nominal 20mm	Underlay	A flexible underlay that complies with Table C.2.1.1 of E2/AS1 and has a 'flammability index' not exceeding 5 can be used
Cladding Fixing	Number/type of nails as per Stria™ Cladding Horizontal Installation Technical Specification	Lining Fixing	Fix GIB Fyreline® with 41mm x 6g GIB® Grabber® High Thread Drywall Screws 300mm centre around the sheet perimeter and intermediate studs Fixing to be 12mm from bound sheet edges and 18mm from sheet ends

For further information refer to Stria™ Cladding Smooth Horizontal Installation Technical Specification.
Stria™ Cladding Fine Texture Horizontal Installation Technical Specification.

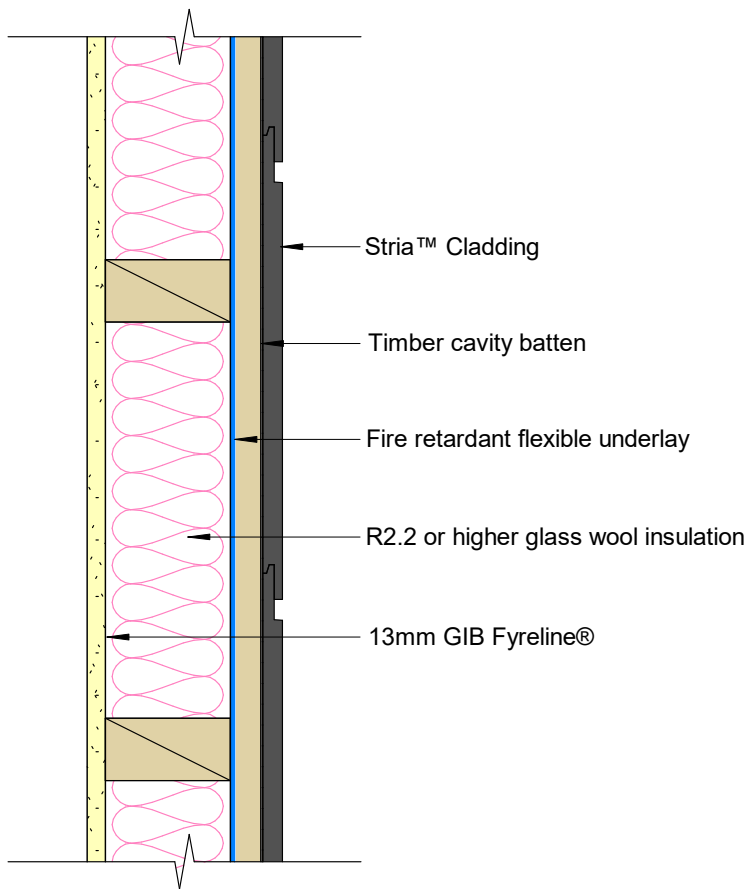

Cladding Stria™ Cladding Smooth - Horizontal

Lining 13mm GIB Fyreline®

Framing Timber framing to be in accordance with NZS 3604 or SED complying with AS/NZS 1170 and NZS 3603. Framing size 90 x 45mm minimum. Studs at 600mm centres and nogs at 800mm centres maximum

Insulation Glass wool insulation 90mm thick, R2.2 or higher.

Cavity Batten Timber cavity batten nominal 20mm

Underlay RAB™ Board

Cladding Fixing Number/type of nails as per Stria™ Cladding Smooth Horizontal Installation Technical Specification

Lining Fixing Fix GIB Fyreline® with 41mm x 6g GIB® Grabber® High Thread Drywall Screws
300mm centre around the sheet perimeter and intermediate studs
Fixing to be 12mm from bound sheet edges and 18mm from sheet ends

RAB™ Board Fixing RAB™ Board 6mm: 40 x 2.8mm fibre cement nail at 200mm centres to entire framing
RAB™ Board 9mm: 50 x 2.8mm fibre cement nail at 200mm centres to entire framing
Fixing to be 12mm from sheet edges

For further information refer to Stria™ Cladding Smooth Horizontal Installation Technical Specification.

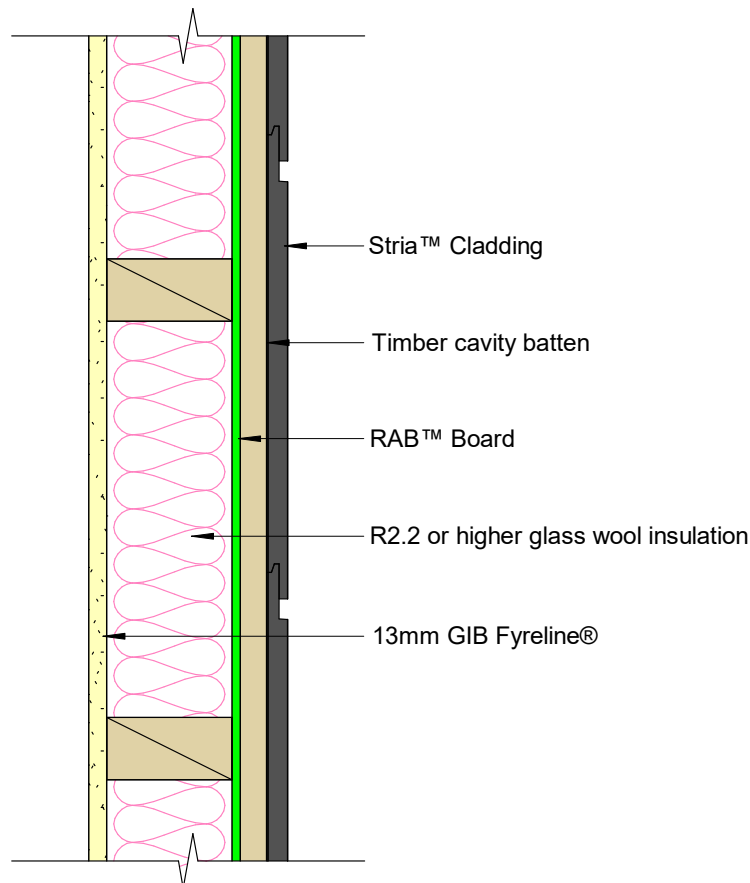

Cladding	Stria™ Cladding Smooth/Fine Texture - Vertical	Lining	13mm GIB Fyreline®
Framing	Timber framing to be in accordance with NZS 3604 or SED complying with AS/NZS 1170 and NZS 3603. Framing size 90 x 45mm minimum. Studs at centres and nogs at 600mm centres maximum 800mm for Smooth and 600mm for Fine Texture	Insulation	Glass wool insulation 90mm thick, R2.2 or higher.
Cavity Batten	Hardie™ horizontal timber cavity batten 20mm	Underlay	A flexible underlay that complies with Table C.2.1.1 of E2/AS1 and has a 'flammability index' not exceeding 5 can be used
Cladding Fixing	Number/type of nails as per Stria™ Cladding Vertical Installation Technical Specification	Lining Fixing	Fix GIB Fyreline® with 41mm x 6g GIB® Grabber® High Thread Drywall Screws 300mm centre around the sheet perimeter and intermediate studs Fixing to be 12mm from bound sheet edges and 18mm from sheet ends

For further information refer to Stria™ Cladding Smooth Vertical Installation Technical Specification.
Stria™ Cladding Fine Texture Vertical Installation Technical Specification.

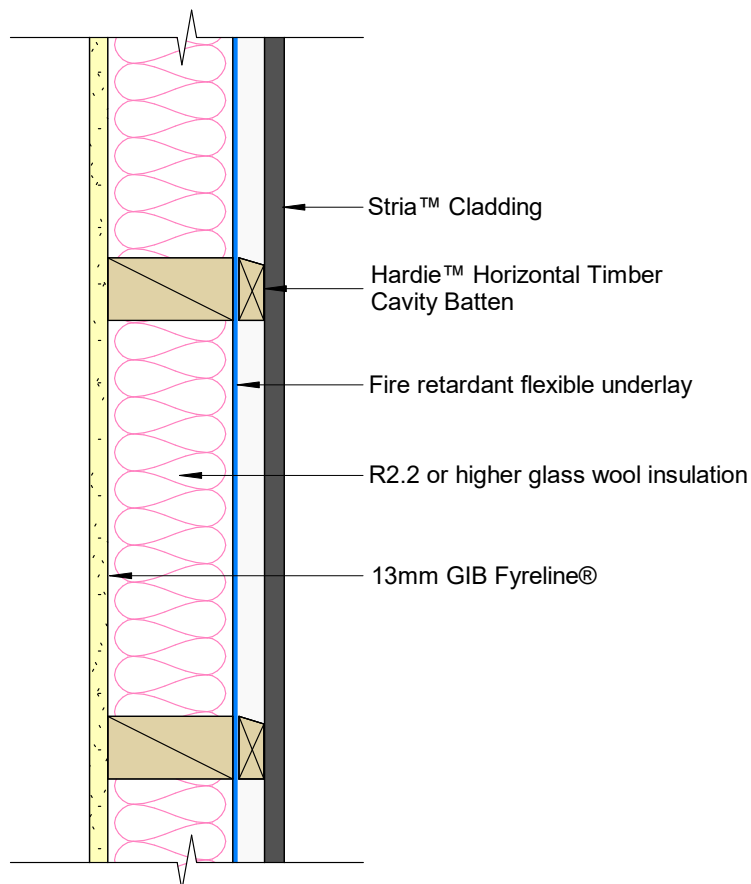

Cladding	Stria™ Cladding Smooth - Vertical	Lining	13mm GIB Fyrelite®
Framing	Timber framing to be in accordance with NZS 3604 or SED complying with AS/NZS 1170 and NZS 3603. Framing size 90 x 45mm minimum. Studs at 600mm centres and nogs at 800mm centres maximum	Insulation	Glass wool insulation 90mm thick, R2.2 or higher.
Cavity Batten	Hardie™ horizontal timber cavity batten 20mm	Underlay	RAB™ Board
Cladding Fixing	Number/type of nails as per Stria™ Cladding Smooth Vertical Installation Technical Specification	Lining Fixing	Fix GIB Fyrelite® with 41mm x 6g GIB® Grabber® High Thread Drywall Screws 300mm centre around the sheet perimeter and intermediate studs Fixing to be 12mm from bound sheet edges and 18mm from sheet ends
RAB™ Board Fixing	RAB™ Board 6mm: 40 x 2.8mm fibre cement nail at 200mm centres to entire framing RAB™ Board 9mm: 50 x 2.8mm fibre cement nail at 200mm centres to entire framing Fixing to be 12mm from sheet edges		

For further information refer to Stria™ Cladding Smooth Vertical Installation Technical Specification.

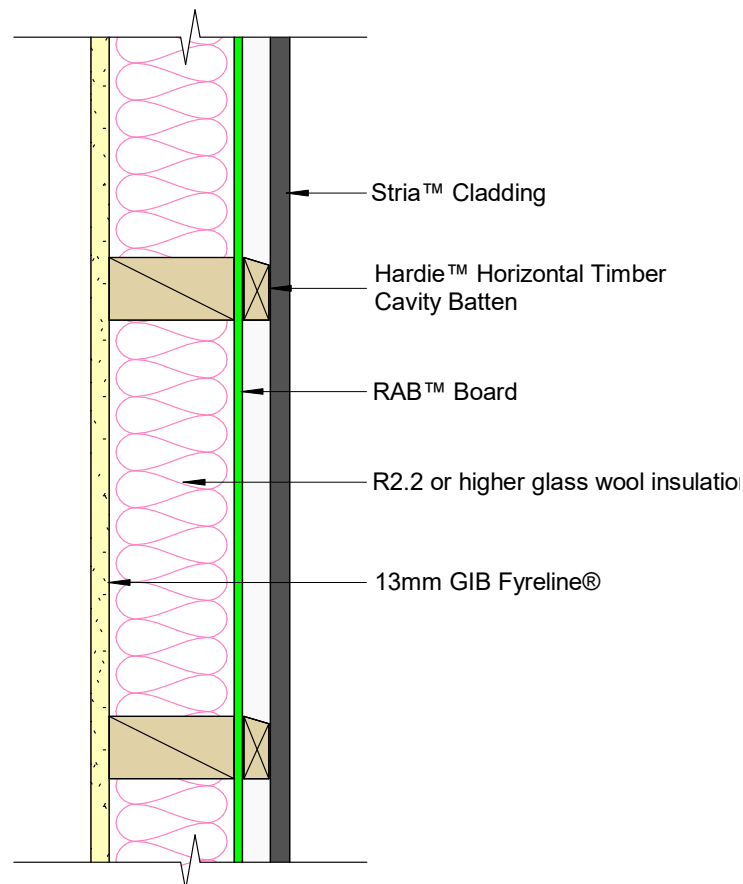

Cladding	Hardie™ Flex Sheet	Lining	13mm GIB Fyreline®
Framing	Timber framing to be in accordance with NZS 3604 or SED complying with AS/NZS 1170 and NZS 3603. Framing size 90 x 45mm minimum. Studs at 600mm centres and nogs at 800mm centres maximum	Insulation	Hardie™ Mineral Insulation
Cavity Batten	Timber cavity batten nominal 20mm	Underlay	A flexible underlay that complies with Table C.2.1.1 of E2/AS1 and has a 'flammability index' not exceeding 5 can be used
Cladding Fixing	Direct Fix: 40 x 2.8mm fibre cement nail at 150mm centres to entire frame Cavity Fix: 60 x 3.15mm fibre cement nail at 150mm centres to entire frame	Lining Fixing	Fix GIB Fyreline® with 41mm x 6g GIB® Grabber® High Thread Drywall Screws 300mm centre around the sheet perimeter and intermediate studs Fixing to be 12mm from bound sheet edges and 18mm from sheet ends

For further information refer to Hardie™ Flex Sheet Technical Specification.

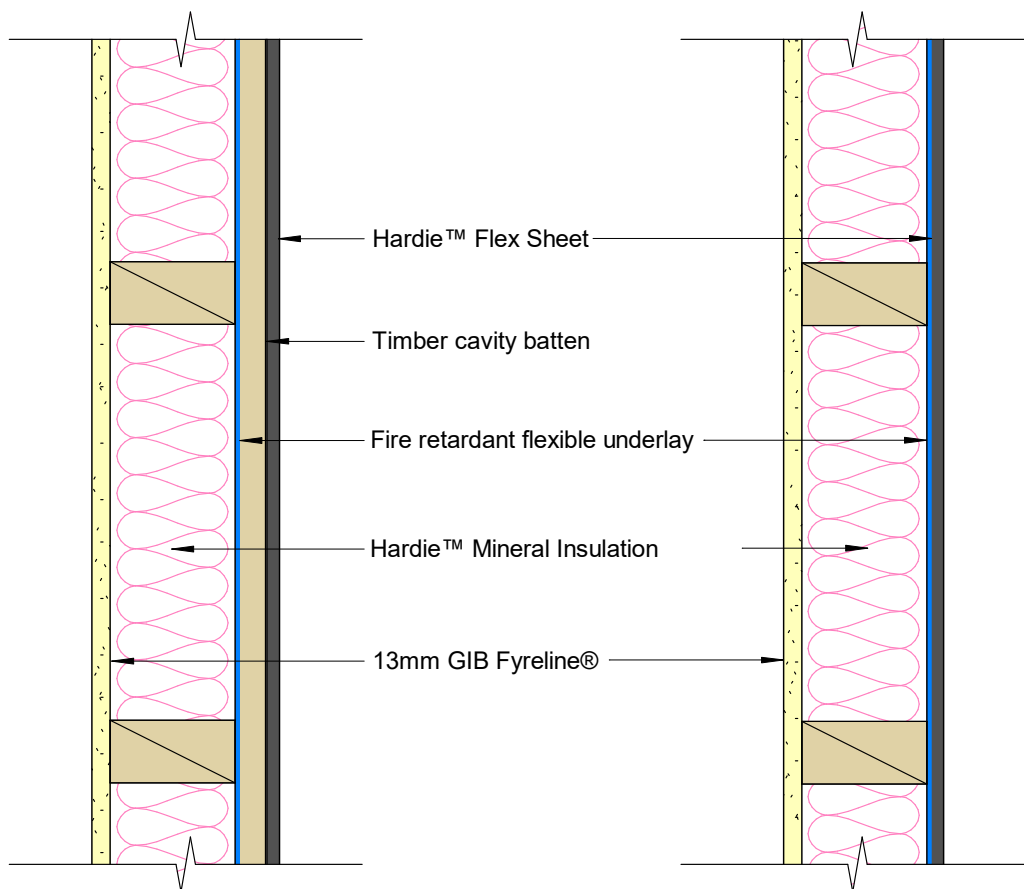

JHETGA60

Fire Resistance 60/60/60

STC 43

Under 10m

Cladding	Axon™ Panel	Lining	13mm GIB Fyrelite®
Framing	Timber framing to be in accordance with NZS 3604 or SED complying with AS/NZS 1170 and NZS 3603. Framing size 90 x 45mm minimum. Studs at 600mm centres and nogs at 800mm centres maximum	Insulation	Hardie™ Mineral Insulation
Cavity Batten	Timber cavity batten nominal 20mm	Underlay	A flexible underlay that complies with Table C.2.1.1 of E2/AS1 and has a 'flammability index' not exceeding 5 can be used
Cladding Fixing	Direct Fix: 40 x 2.8mm round head nail at 150mm centres to entire frame Cavity Fix: 60 x 3.15mm round head nail at 150mm centres to entire frame	Lining Fixing	Fix GIB Fyrelite® with 41mm x 6g GIB® Grabber® High Thread Drywall Screws 300mm centre around the sheet perimeter and intermediate studs Fixing to be 12mm from bound sheet edges and 18mm from sheet ends

For further information refer to Axon™ Panel Timber Cavity Batten or Direct Fix Technical Specification.

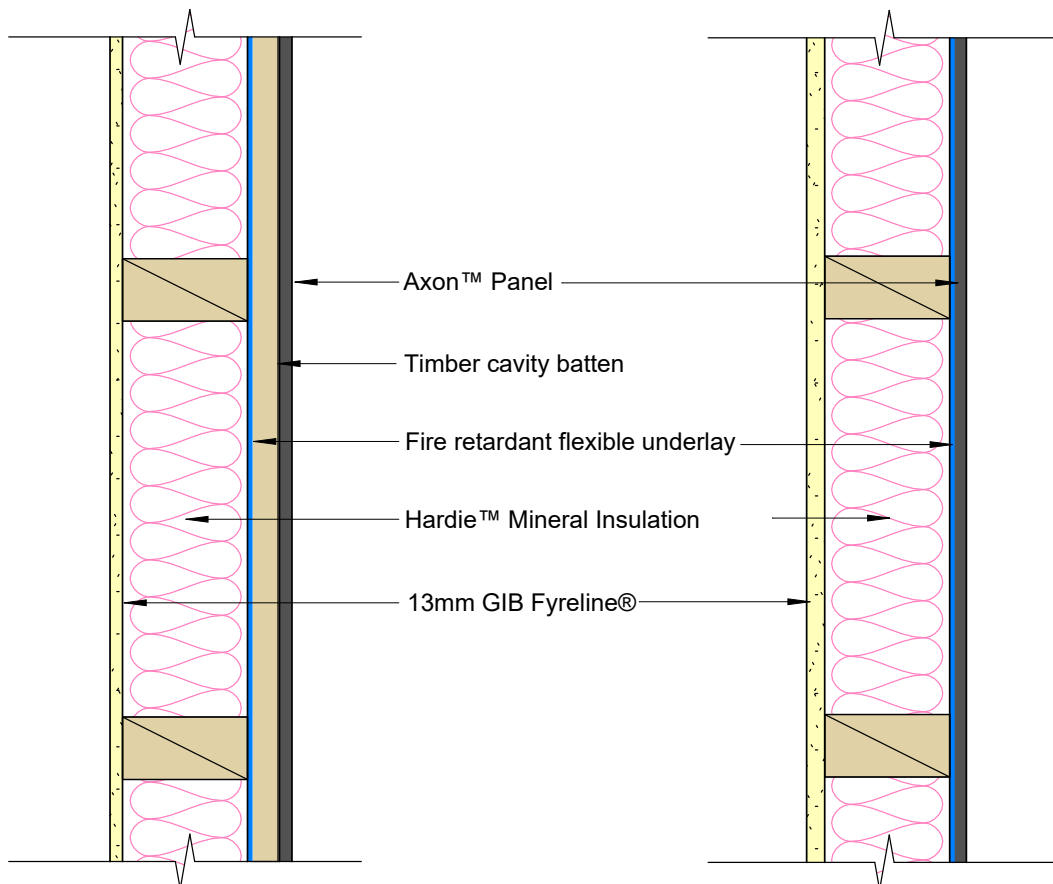

Cladding	Axon™ Panel	Lining	13mm GIB Fyreline®
Framing	Timber framing to be in accordance with NZS 3604 or SED complying with AS/NZS 1170 and NZS 3603. Framing size 90 x 45mm minimum. Studs at 600mm centres and nogs at 800mm centres maximum	Insulation	Hardie™ Mineral Insulation
Cavity Batten	70 x 19mm Hardie™ CLD™ Structural Cavity Batten	Underlay	RAB™ Board
Cladding Fixing	As per Axon™ Panel Fixed to Hardie™ CLD™ Structural Cavity Batten Technical Specification	Lining Fixing	Fix GIB Fyreline® with 41mm x 6g GIB® Grabber® High Thread Drywall Screws 300mm centre around the sheet perimeter and intermediate studs Fixing to be 12mm from bound sheet edges and 18mm from sheet ends
RAB™ Board Fixing	RAB™ Board 6mm: 40 x 2.8mm fibre cement nail at 150mm centres to entire framing RAB™ Board 9mm: 50 x 2.8mm fibre cement nail at 150mm centres to entire framing Fixing to be 12mm from sheet edges		

No cladding required for wall applications enclosed within the roof space.
For further information refer to HomeRAB™ Pre-Cladding and RAB™ Board Installation Manual.

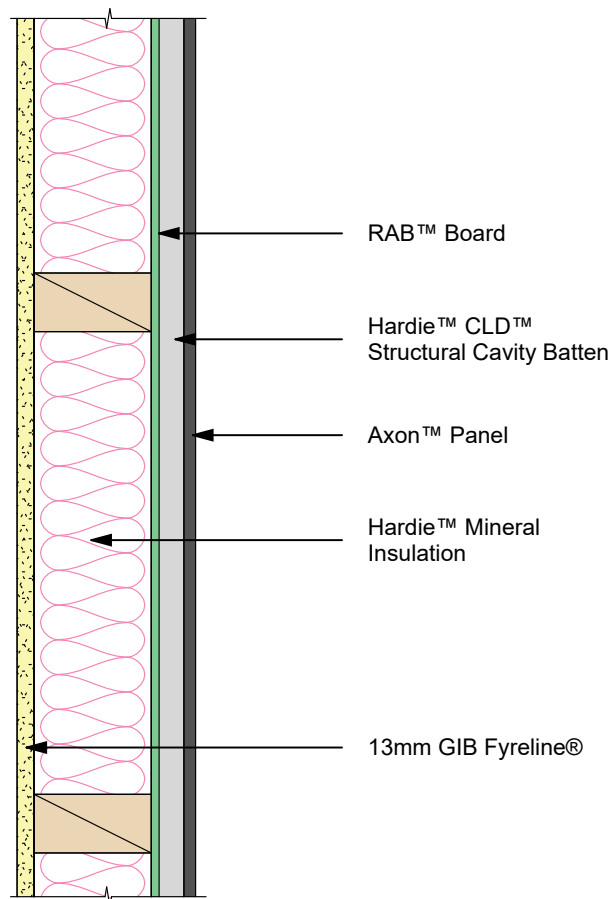

Cladding	ExoTec™ Facade Panel	Lining	13mm GIB Fyreline®
Framing	Timber framing to be in accordance with NZS 3604 or SED complying with AS/NZS 1170 and NZS 3603. Framing size 90 x 45mm minimum. Studs at 600mm centres and nogs at 800mm centres maximum	Insulation	Hardie™ Mineral Insulation
Cavity Batten	ExoTec™ Top Hat System	Underlay	RAB™ Board
Cladding Fixing	As per ExoTec™ Facade Panel Top Hat Technical Specification	Lining Fixing	Fix GIB Fyreline® with 41mm x 6g GIB® Grabber® High Thread Drywall Screws 300mm centre around the sheet perimeter and intermediate studs Fixing to be 12mm from bound sheet edges and 18mm from sheet ends
RAB™ Board Fixing	RAB™ Board 6mm: 40 x 2.8mm fibre cement nail at 150mm centres to entire framing RAB™ Board 9mm: 50 x 2.8mm fibre cement nail at 150mm centres to entire framing Fixing to be 12mm from sheet edges		

No cladding required for wall applications enclosed within the roof space.
For further information refer to HomeRAB™ Pre-Cladding and RAB™ Board Installation Manual.

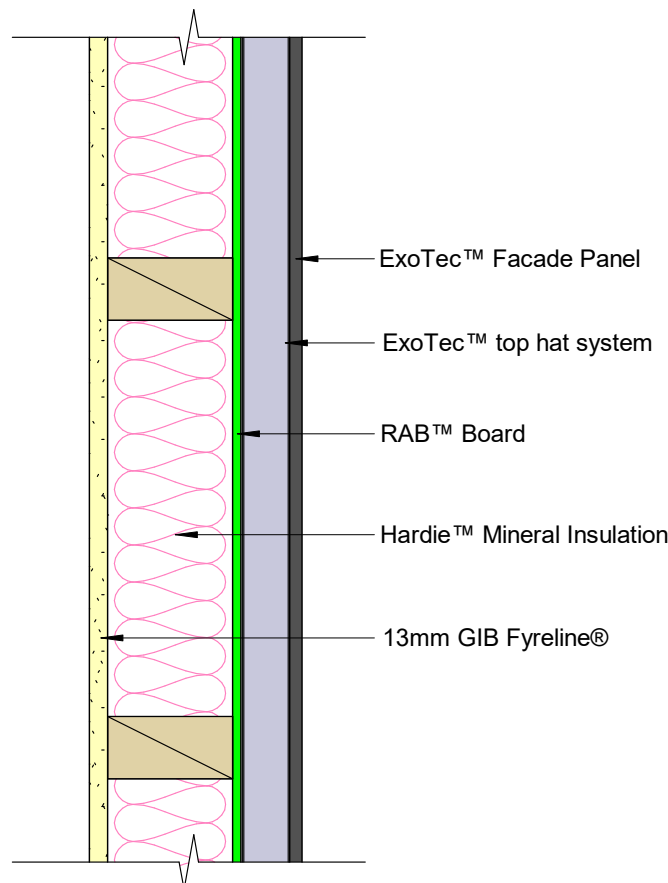

Cladding	Brick to the NZS 4210	Lining	13mm GIB Fyrelime®
Framing	Timber framing to be in accordance with NZS 3604 or SED complying with AS/NZS 1170 and NZS 3603. Framing size 90 x 45mm minimum. Studs at 600mm centres and nogs at 800mm centres maximum	Insulation	Glass wool insulation 90mm thick, R2.2 or higher
Cavity	As per cladding manufacturer technical specification	Underlay	RAB™ Board
Cladding Fixing	As per cladding manufacturer technical specification	Lining Fixing	Fix GIB Fyrelime® with 41mm x 6g GIB® Grabber® High Thread Drywall Screws 300mm centre around the sheet perimeter and intermediate studs Fixing to be 12mm from bound sheet edges and 18mm from sheet ends
RAB™ Board Fixing	RAB™ Board 6mm: 40 x 2.8mm fibre cement nail at 150mm centres to entire framing RAB™ Board 9mm: 50 x 2.8mm fibre cement nail at 150mm centres to entire framing Fixing to be 12mm from sheet edges		

No cladding required for wall applications enclosed within the roof space.
For further information refer to HomeRAB™ Pre-Cladding and RAB™ Board Installation Manual.

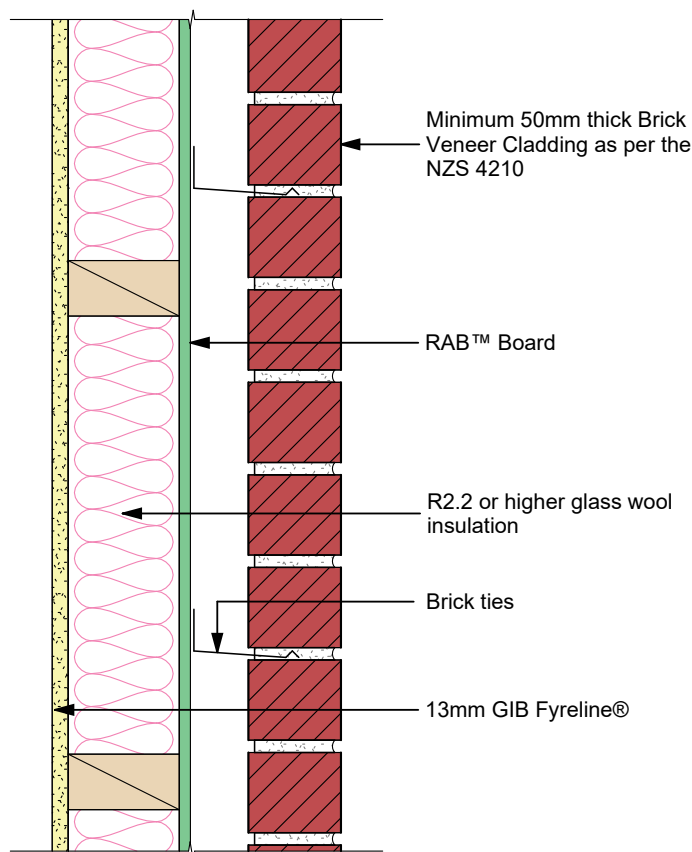

Cladding	Cladding system as per Table 5.3.1.1 of C/AS1 and Table 8.4.1.2 of Building Product Specifications	Lining	13mm GIB Fyrelite®
Framing	Timber framing to be in accordance with NZS 3604 or SED complying with AS/NZS 1170 and NZS 3603. Framing size 90 x 45mm minimum. Studs at 600mm centres and nogs at 800mm centres maximum	Insulation	Hardie™ Mineral Insulation
Cavity Batten	As per cladding manufacturer technical specification	Underlay	RAB™ Board
Cladding Fixing	As per cladding manufacturer technical specification	Lining Fixing	Fix GIB Fyrelite® with 41mm x 6g GIB® Grabber® High Thread Drywall Screws 300mm centre around the sheet perimeter and intermediate studs Fixing to be 12mm from bound sheet edges and 18mm from sheet ends
RAB™ Board Fixing	RAB™ Board 6mm: 40 x 2.8mm fibre cement nail at 150mm centres to entire framing RAB™ Board 9mm: 50 x 2.8mm fibre cement nail at 150mm centres to entire framing Fixing to be 12mm from sheet edges		

No cladding required for wall applications enclosed within the roof space.
For further information refer to HomeRAB™ Pre-Cladding and RAB™ Board Installation Manual.

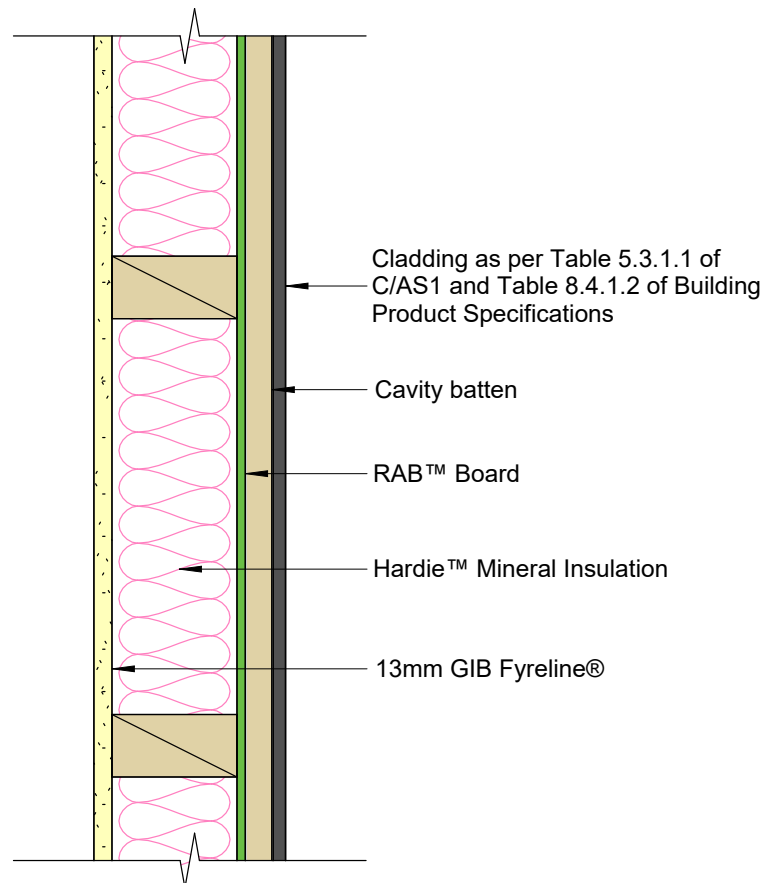

JHETVA60

Fire Resistance 60/60/60

STC 42

Under 10m

Cladding	Axon™ Panel	Lining	Villaboard™ Lining
Framing	Timber framing to be in accordance with NZS 3604 or SED complying with AS/NZS 1170 and NZS 3603. Framing size 90 x 45mm minimum. Studs at 600mm centres and nogs at 800mm centres maximum	Insulation	Hardie™ Mineral Insulation
Cavity Batten	Timber cavity batten nominal 20mm	Underlay	A flexible underlay that complies with Table C.2.1.1 of E2/AS1 and has a 'flammability index' not exceeding 5 can be used
Cladding Fixing	Direct Fix: 40 x 2.8mm round head nail at 150mm centres to entire frame Cavity Fix: 60 x 3.15mm round head nail at 150mm centres to entire frame	Lining Fixing	Fix Villaboard™ Lining with Villadrive™ 30mm x 7g wood screw or 40 x 2.8mm fibre cement nails at 150mm maximum centres

For further information refer to Axon™ Panel Timber Cavity Batten or Direct Fix Technical Specification.
For further information refer to Villaboard™ Lining Installation Manual.

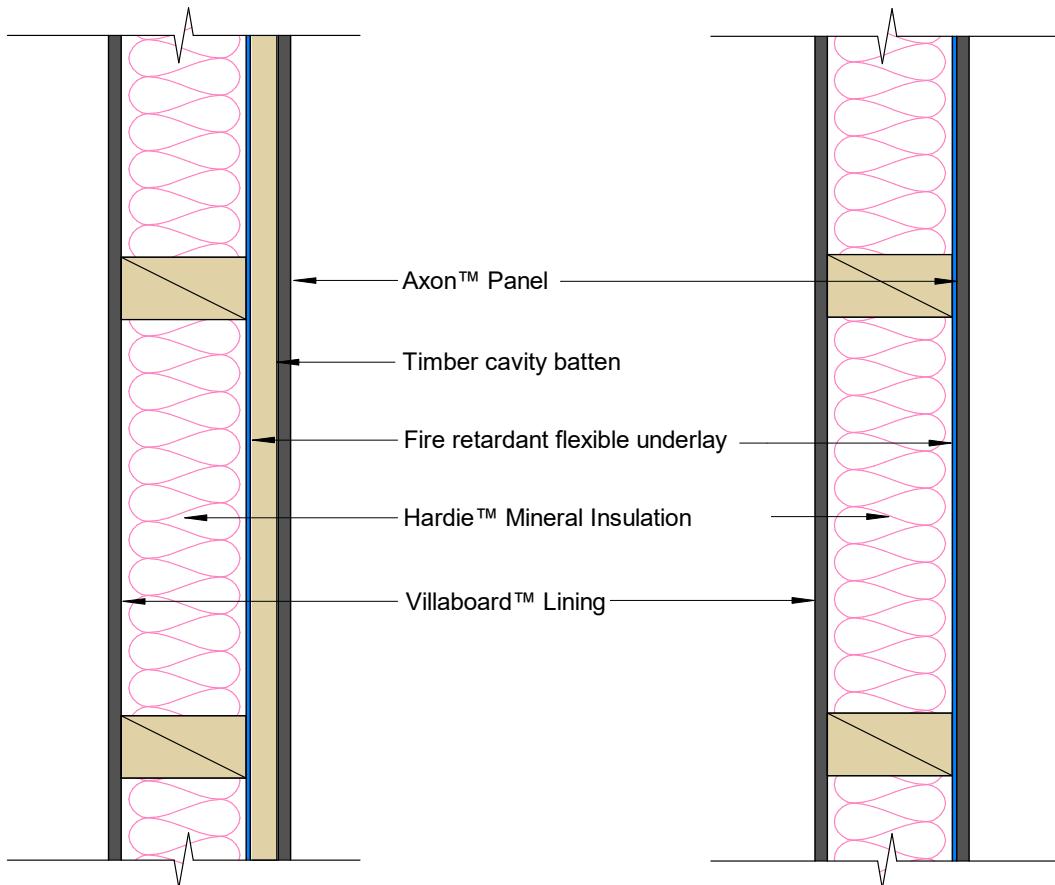

JHETVL60

Fire Resistance 60/60/60

STC 45

Under 10m

Cladding	Linea™ Weatherboard	Lining	Villaboard™ Lining
Framing	Timber framing to be in accordance with NZS 3604 or SED complying with AS/NZS 1170 and NZS 3603. Framing size 90 x 45mm minimum. Studs at 600mm centres and nogs at 800mm centres maximum	Insulation	Hardie™ Mineral Insulation
Cavity Batten	Timber cavity batten nominal 20mm	Underlay	A flexible underlay that complies with Table C.2.1.1 of E2/AS1 and has a 'flammability index' not exceeding 5 can be used
Cladding Fixing	Face fixed with 90 x 3.55mm jolt head nails to studs	Lining Fixing	Fix Villaboard™ Lining with Villadrive™ 30mm x 7g wood screw or 40 x 2.8mm fibre cement nails at 150mm maximum centres

For further information refer to Linea™ Weatherboard Cavity Fix or Direct Fix Technical Specification.
For further information refer to Villaboard™ Lining Installation Manual.

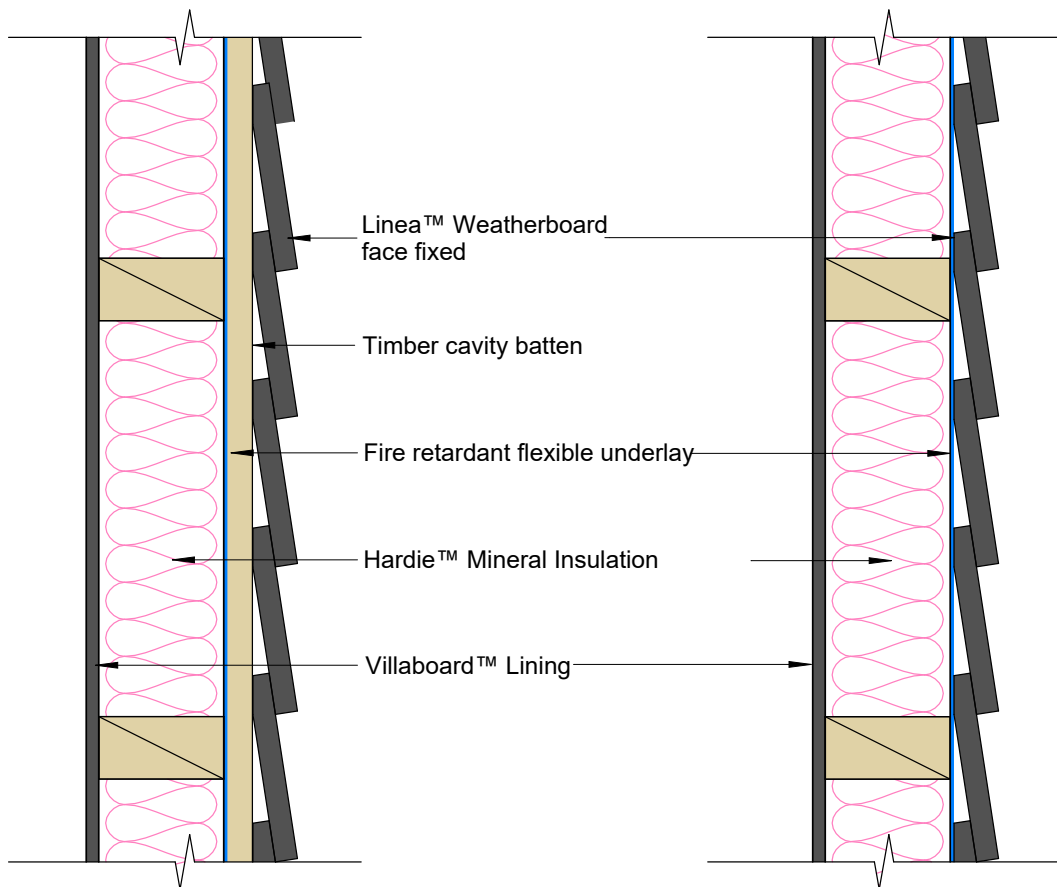

Cladding	Cladding system as per Table 5.3.1.1 of C/AS1 and Table 8.4.1.2 of Building Product Specifications	Lining	Villaboard™ Lining
Framing	Timber framing to be in accordance with NZS 3604 or SED complying with AS/NZS 1170 and NZS 3603. Framing size 90 x 45mm minimum. Studs at 600mm centres and nogs at 800mm centres maximum. For intertenancy walls double frame with 25mm gap between frames.	Insulation	Hardie™ Mineral Insulation
Cavity Batten	As per cladding manufacturer technical specification.	Underlay	RAB™ Board
Cladding Fixing	As per cladding manufacturer technical specification	Lining Fixing	Fix Villaboard™ Lining with Villadrive™ 30mm x 7g wood screw or 40 x 2.8mm fibre cement nails at 150mm maximum centres
RAB™ Board Fixing	RAB™ Board 6mm: 40 x 2.8mm fibre cement nail at 150mm centres to entire framing RAB™ Board 9mm: 50 x 2.8mm fibre cement nail at 150mm centres to entire framing Fixing to be 12mm from sheet edges		

*STC value for IT wall

For further information refer to HomeRAB™ Pre-Cladding and RAB™ Board Installation Manual.
For further information refer to Villaboard™ Lining Installation Manual.

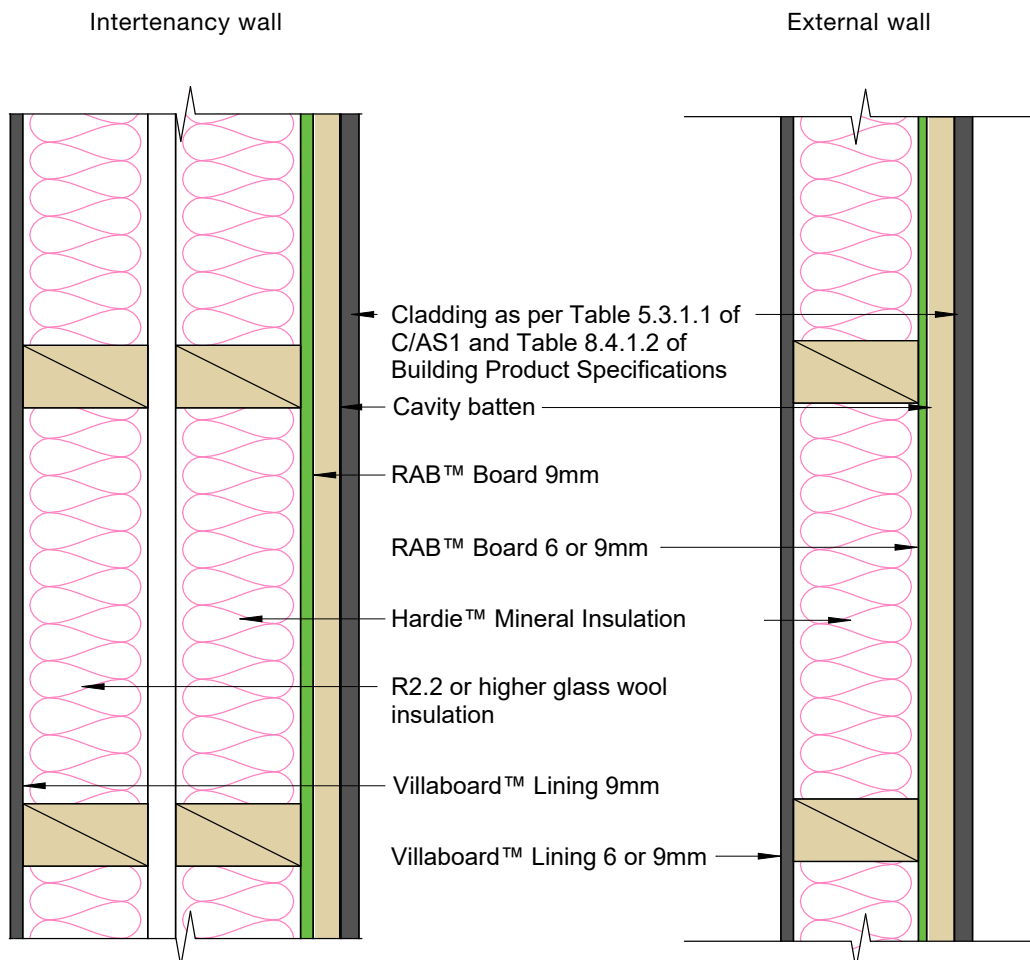

Cladding	Cladding system as per Table 5.3.1.1 of C/AS1 and Table 8.4.1.2 of Building Product Specifications	Lining	Villaboard™ Lining 9mm
Framing	Timber framing to be in accordance with the NZS 3604 or SED complying with AS/NZS 1170 and NZS 3603. Framing size 90 x 45mm minimum. Studs at 600mm centres and nogs at 800mm centres maximum Double frame with 25mm gap between frames	Insulation	2 x Hardie™ Mineral Insulation
Cavity Batten	As per cladding manufacturer technical specification.	Underlay	RAB™ Board 9mm
Cladding Fixing	As per cladding manufacturer technical specification	Lining Fixing	Fix Villaboard™ Lining with Villadrive™ 30mm x 7g wood screw or 40 x 2.8mm fibre cement nails at 150mm maximum centres Fixing to be 12mm from sheet edges
RAB™ Board Fixing	50 x 2.8mm fibre cement nail at 150mm centres to entire framing Fixing to be 12mm from sheet edges		

No cladding required for wall applications enclosed within the roof space
 For further information refer to HomeRAB™ Pre-Cladding and RAB™ Board Installation Manual.
 For further information refer to Villaboard™ Lining Installation Manual.

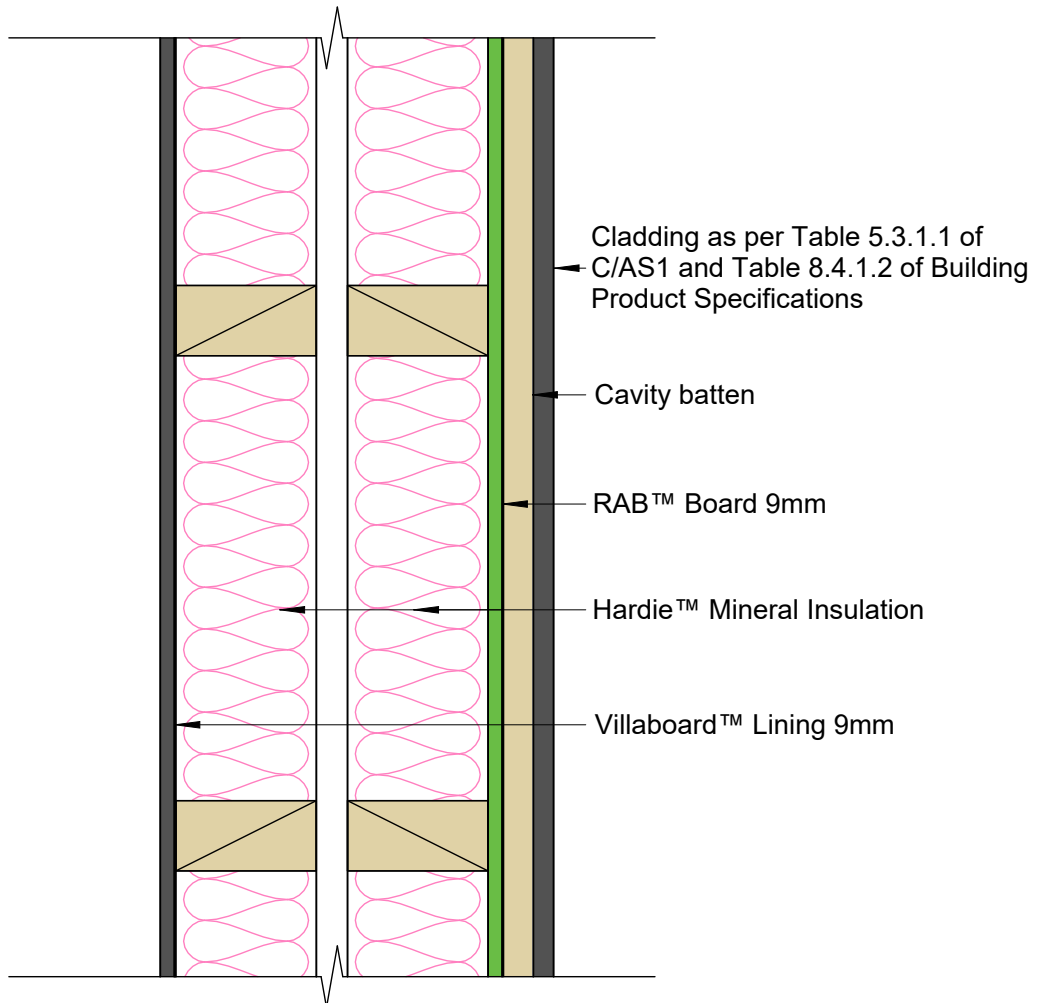

External Walls Steel Frame

30 Minute Fire Rated System

60 Minute Fire Rated System

Cladding	Cladding system as per Table 5.3.1.1 of C/AS1 and Table 8.4.1.2 of Building Product Specifications	Lining	2 x 10mm GIB Fyreline®
Framing	Steel framing to be in accordance with NASH Standard 'Light Steel Framed Buildings'. Framing size 89 x 39 x 0.75mm. Studs at 400mm centres and nogs at 800mm centres maximum.	Insulation	Hardie™ Mineral Insulation
Cavity Batten	As per cladding manufacturer technical specification	Underlay	RAB™ Board over thermal fire batten (refer to page 14)
Cladding Fixing	As per cladding manufacturer technical specification	Lining Fixing	Inner layer: 25mm x 6g GIB® Grabber® Drywall Self Tapping Screws Outer layer: 32mm x 6g GIB® Grabber® Drywall Self Tapping Screws Inner layer: 600mm centres up each stud Outer layer: 300mm centre around the sheet perimeter and intermediate studs Fixing to be 12mm from bound sheet edges and 50mm from sheet ends
RAB™ Board Fixing	50mm x 10g steel self embedding steel screws at 150mm centres to entire framing Fixing to be 12mm from sheet edges		

No cladding required for wall applications enclosed within the roof space.
For further information refer to HomeRAB™ Pre-Cladding and RAB™ Board Installation Manual.

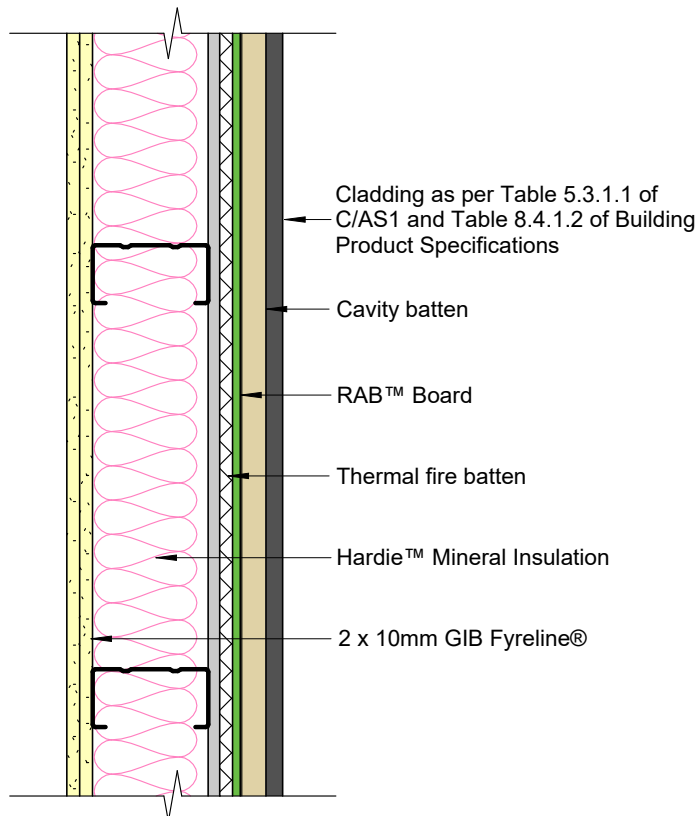

Cladding	Cladding system as per Table 5.3.1.1 of C/AS1 and Table 8.4.1.2 of Building Product Specifications	Lining	2 x 13mm GIB Fyrelite®
Framing	Steel framing to be in accordance with NASH Standard 'Light Steel Framed Buildings'. Framing size 89 x 39 x 0.75mm. Studs at 400mm centres and nogs at 800mm centres maximum.	Insulation	Hardie™ Mineral Insulation
Cavity Batten	As per cladding manufacturer technical specification	Underlay	RAB™ Board over thermal fire batten (refer to page 14)
Cladding Fixing	As per cladding manufacturer technical specification	Lining Fixing	Inner layer: 25mm x 6g GIB® Grabber® Drywall Self Tapping Screws Outer layer: 41mm x 6g GIB® Grabber® Drywall Self Tapping Screws Inner layer: 600mm centres up each stud Outer layer: 300mm centre around the sheet perimeter and intermediate studs Fixing to be 12mm from bound sheet edges and 50mm from sheet ends
RAB™ Board Fixing	50mm x 10g steel self embedding steel screws at 150mm centres to entire framing Fixing to be 12mm from sheet edges		

No cladding required for wall applications enclosed within the roof space.
For further information refer to HomeRAB™ Pre-Cladding and RAB™ Board Installation Manual.

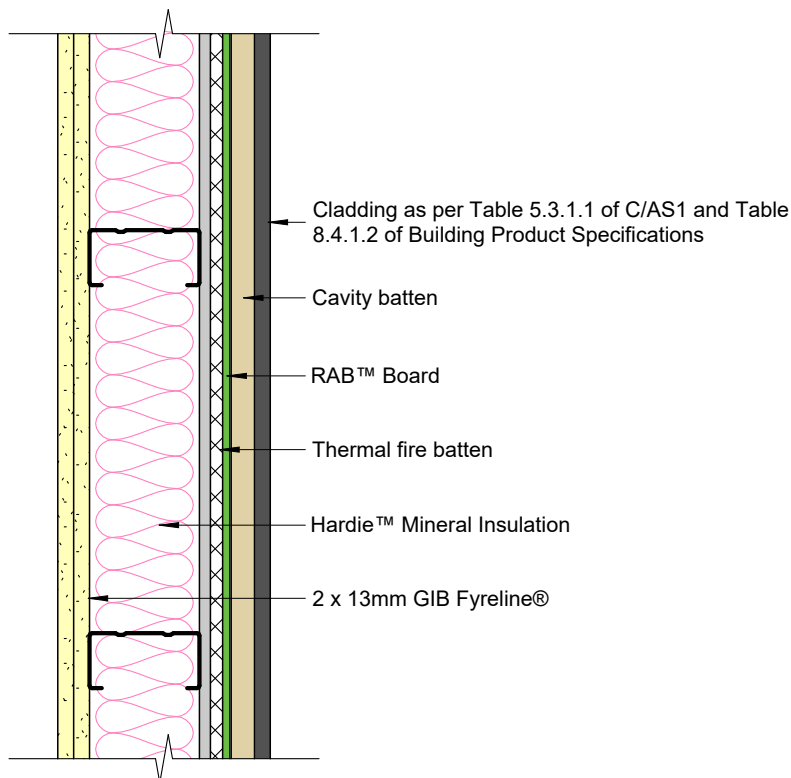

Parapet & Wing Walls Timber Frame

30 Minute Fire Rated System

60 Minute Fire Rated System

Cladding	Linea™ Weatherboard	Insulation	Hardie™ Mineral Insulation
Framing	Timber framing to be in accordance with NZS 3604 or SED complying with AS/NZS 1170 and NZS 3603. Framing size 90 x 45mm minimum. Studs at 600mm centres and nogs at 800mm centres maximum	Underlay	A flexible underlay that complies with Table C.2.1.1 of E2/AS1 and has a 'flammability index' not exceeding 5 can be used
Cavity Batten	Timber cavity batten nominal 20mm		
Cladding Fixing	Cavity Fix: Face fixed with 75 x 3.15mm jolt head nails to studs		

For further information refer to Linea™ Weatherboard Cavity Fix Technical Specification.

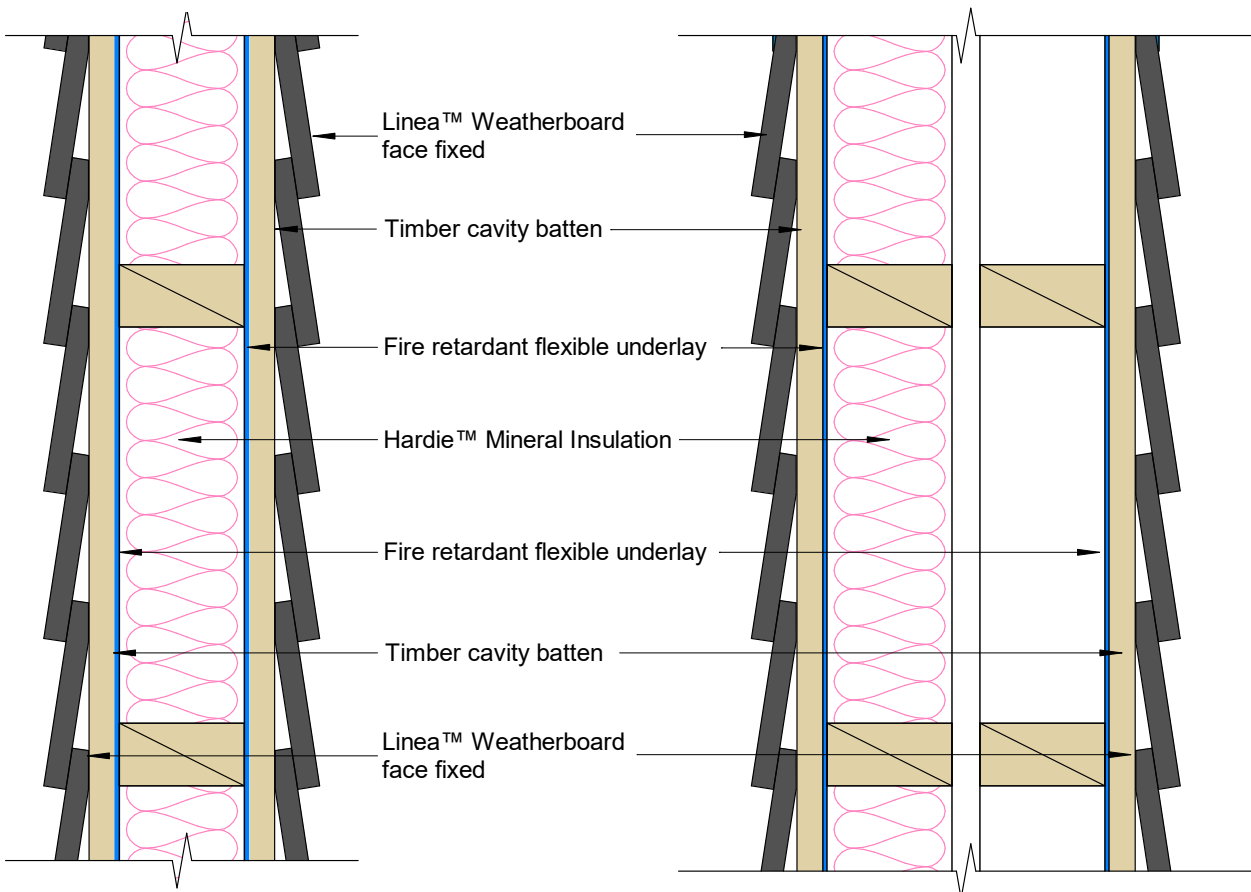

Cladding	Linea™ Weatherboard		
Framing	Timber framing to be in accordance with NZS 3604 or SED complying with AS/NZS 1170 and NZS 3603. Framing size 90 x 45mm minimum. Studs at 600mm centres and nogs at 800mm centres maximum	Insulation	Hardie™ Mineral Insulation
Cavity Batten	Timber cavity batten nominal 20mm	Underlay	RAB™ Board - Both sides of framing
Cladding Fixing	Face fixed with 90 x 3.55mm jolt head nails to studs		
RAB™ Board Fixing	RAB™ Board 6mm: 40 x 2.8mm fibre cement nail at 200mm centres to entire framing RAB™ Board 9mm: 50 x 2.8mm fibre cement nail at 200mm centres to entire framing Fixing to be 12mm from sheet edges		

No cladding required for wall applications enclosed within the roof space.
For further information refer to Linea™ Weatherboard Cavity Fix Technical Specification.

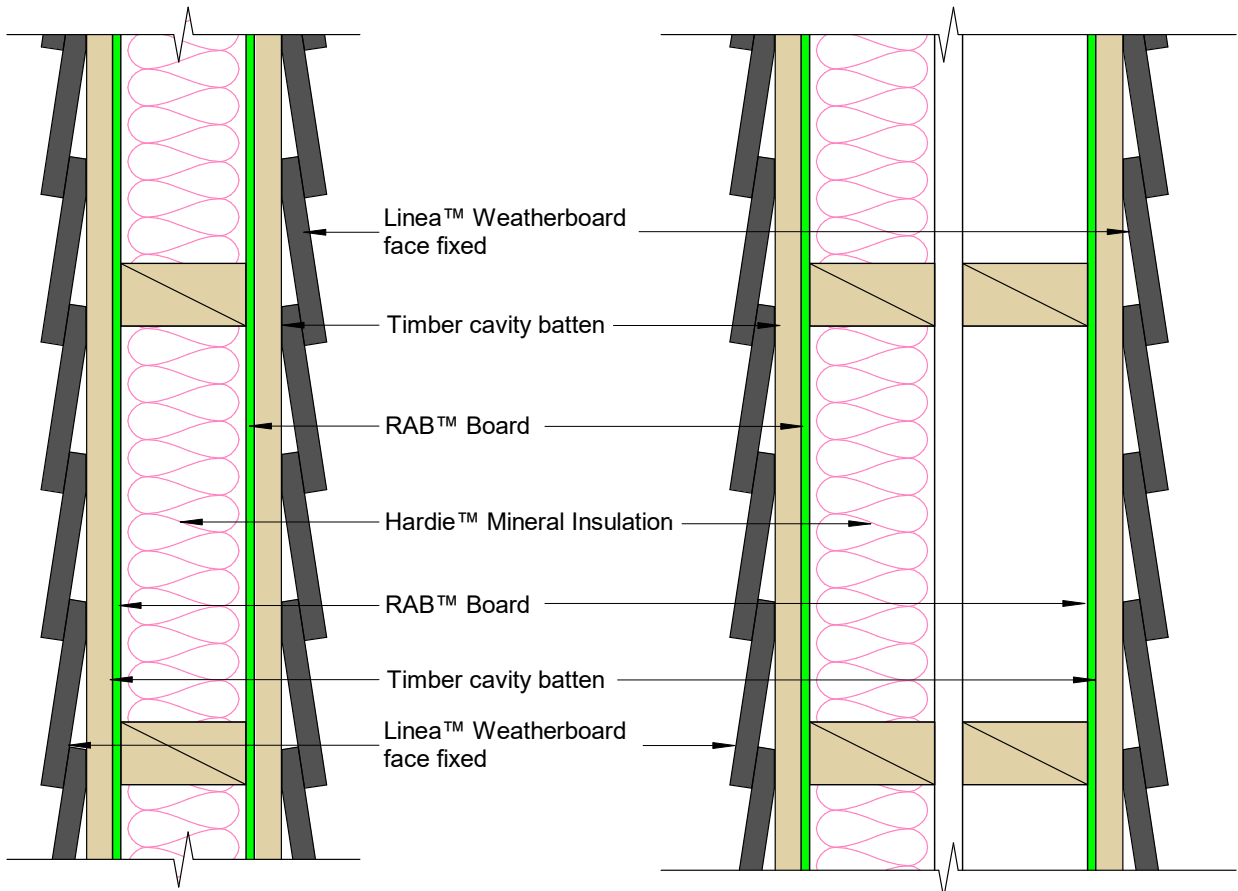

Cladding	Oblique™ Weatherboard - Horizontal	
Framing	Timber framing to be in accordance with NZS 3604 or SED complying with AS/NZS 1170 and NZS 3603. Framing size 90 x 45mm minimum. Studs at 600mm centres and nogs at 800mm centres maximum	Insulation
Cavity Batten	Timber cavity batten nominal 20mm	Underlay
		A flexible underlay that complies with Table C.2.1.1 of E2/AS1 and has a 'flammability index' not exceeding 5 can be used
Cladding Fixing	<p>200mm wide weatherboard: 65 x 2.87mm D-Head or round head nail to stud</p> <p>300mm wide weatherboard: Two nails per stud, 65 x 2.87mm D-Head or round head nail</p>	

For further information refer to Oblique™ Weatherboard Horizontal Installation Technical Specification.

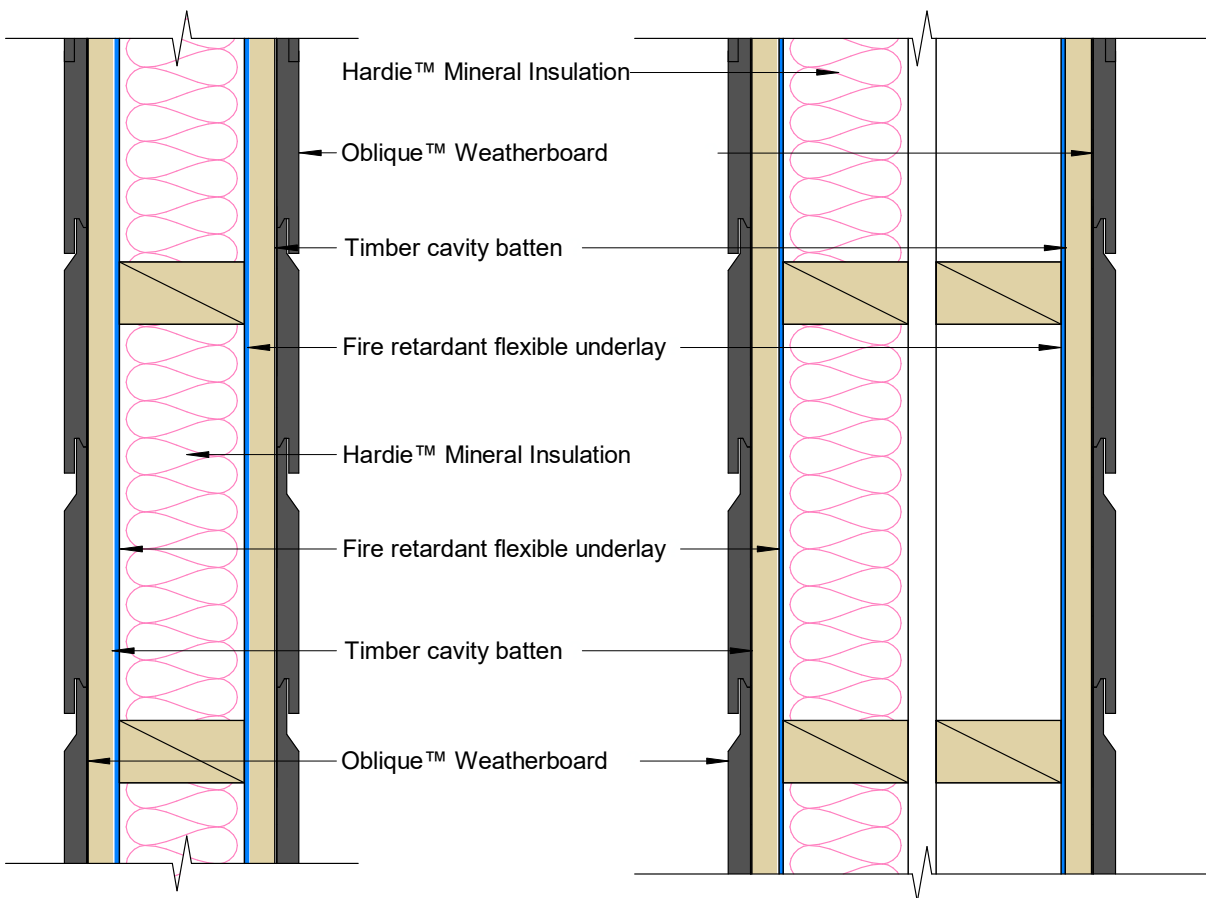

Cladding	Oblique™ Weatherboard - Horizontal	
Framing	Timber framing to be in accordance with NZS 3604 or SED complying with AS/NZS 1170 and NZS 3603. Framing size 90 x 45mm minimum. Studs at 600mm centres and nogs at 800mm centres maximum	Insulation
		Hardie™ Mineral Insulation
Cavity Batten	Timber cavity batten nominal 20mm	Underlay
		RAB™ Board - Both sides of framing
Cladding Fixing	200mm wide weatherboard: 75 x 3.06mm D-Head or round head nail to stud 300mm wide weatherboard: Two nails per stud, 75 x 3.06mm D-Head or round head nail	
RAB™ Board Fixing	RAB™ Board 6mm: 40 x 2.8mm fibre cement nail at 200mm centres to entire framing RAB™ Board 9mm: 50 x 2.8mm fibre cement nail at 200mm centres to entire framing Fixing to be 12mm from sheet edges	

No cladding required for wall applications enclosed within the roof space.
 For further information refer to Oblique™ Weatherboard Horizontal Installation Technical Specification.

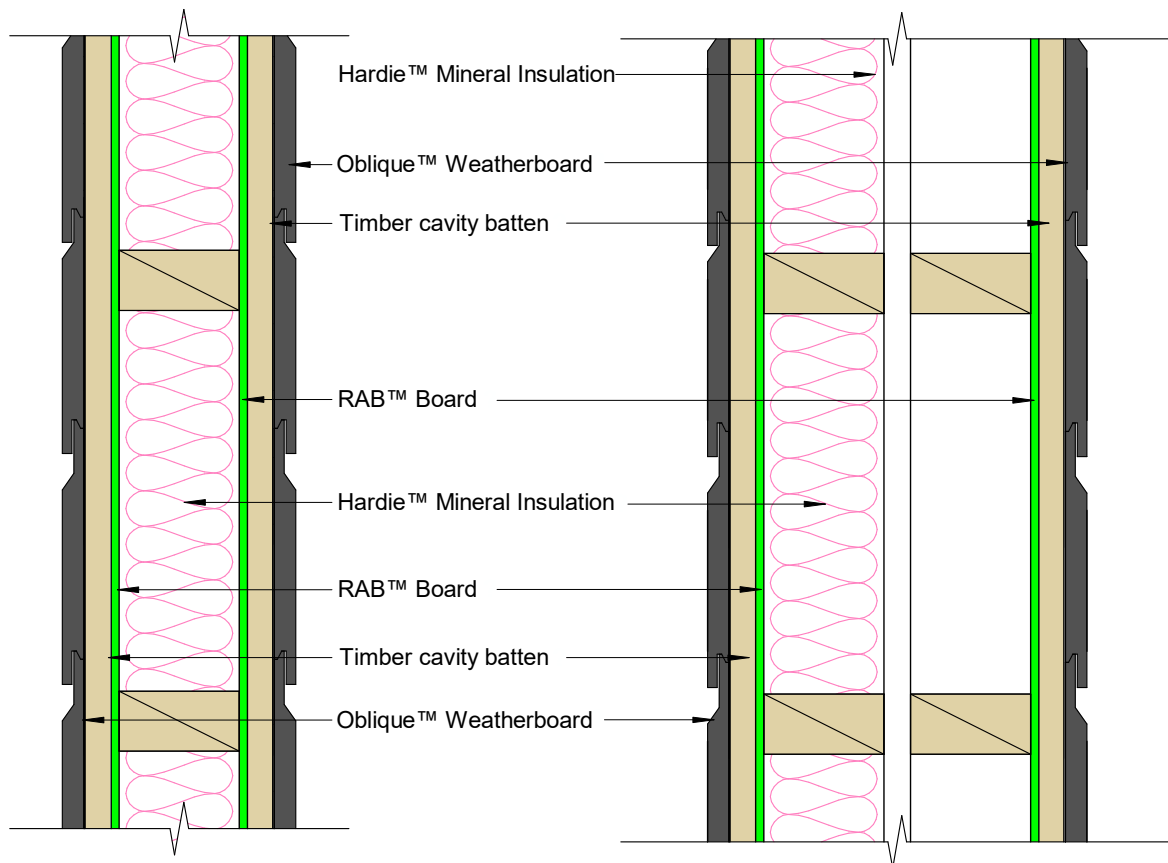

Cladding Oblique™ Weatherboard - Vertical

Framing Timber framing to be in accordance with NZS 3604 or SED complying with AS/NZS 1170 and NZS 3603. Framing size 90 x 45mm minimum. Studs at 600mm centres and nogs at 600mm centres maximum

Insulation Hardie™ Mineral Insulation

Cavity Batten Hardie™ horizontal timber cavity batten 20mm

Underlay A flexible underlay that complies with Table C.2.1.1 of E2/AS1 and has a 'flammability index' not exceeding 5 can be used

Cladding Fixing **200mm wide weatherboard:**
65 x 2.87mm D-Head or round head nail to nog
300mm wide weatherboard:
Two nails per nog, 65 x 2.87mm D-Head or round head nail

For further information refer to Oblique™ Weatherboard Vertical Installation Technical Specification.

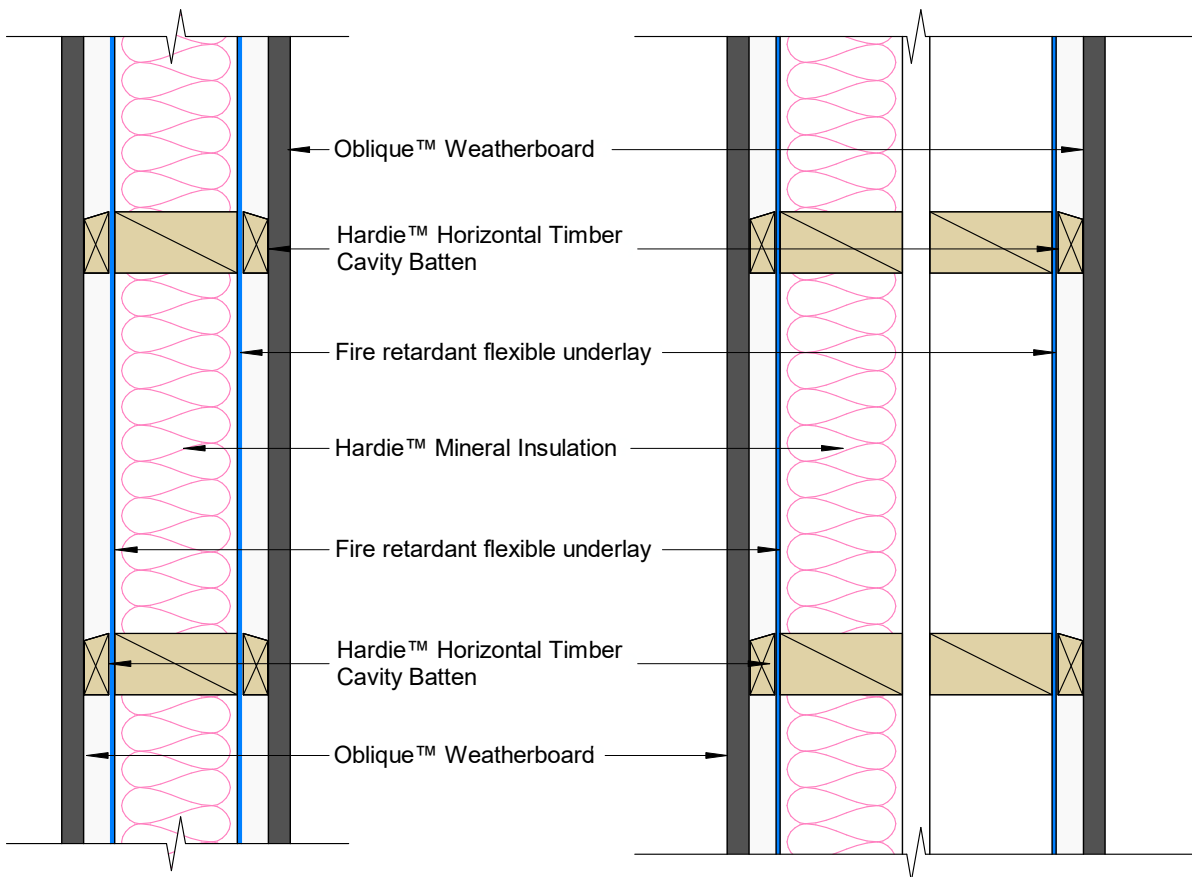

Cladding	Oblique™ Weatherboard - Vertical	
Framing	Timber framing to be in accordance with NZS 3604 or SED complying with AS/NZS 1170 and NZS 3603. Framing size 90 x 45mm minimum. Studs at 600mm centres and nogs at 600mm centres maximum	Insulation
		Hardie™ Mineral Insulation
Cavity Batten	Hardie™ horizontal timber cavity batten 20mm	Underlay
		RAB™ Board - Both sides of framing
Cladding Fixing	<p>200mm wide weatherboard: 75 x 3.06mm D-Head or round head nail to nog</p> <p>300mm wide weatherboard: Two nails per nog, 75 x 3.06mm D-Head or round head nail</p>	
RAB™ Board Fixing	<p>RAB™ Board 6mm: 40 x 2.8mm fibre cement nail at 200mm centres to entire framing</p> <p>RAB™ Board 9mm: 50 x 2.8mm fibre cement nail at 200mm centres to entire framing</p> <p>Fixing to be 12mm from sheet edges</p>	

No cladding required for wall applications enclosed within the roof space.
For further information refer to Oblique™ Weatherboard Vertical Installation Technical Specification.

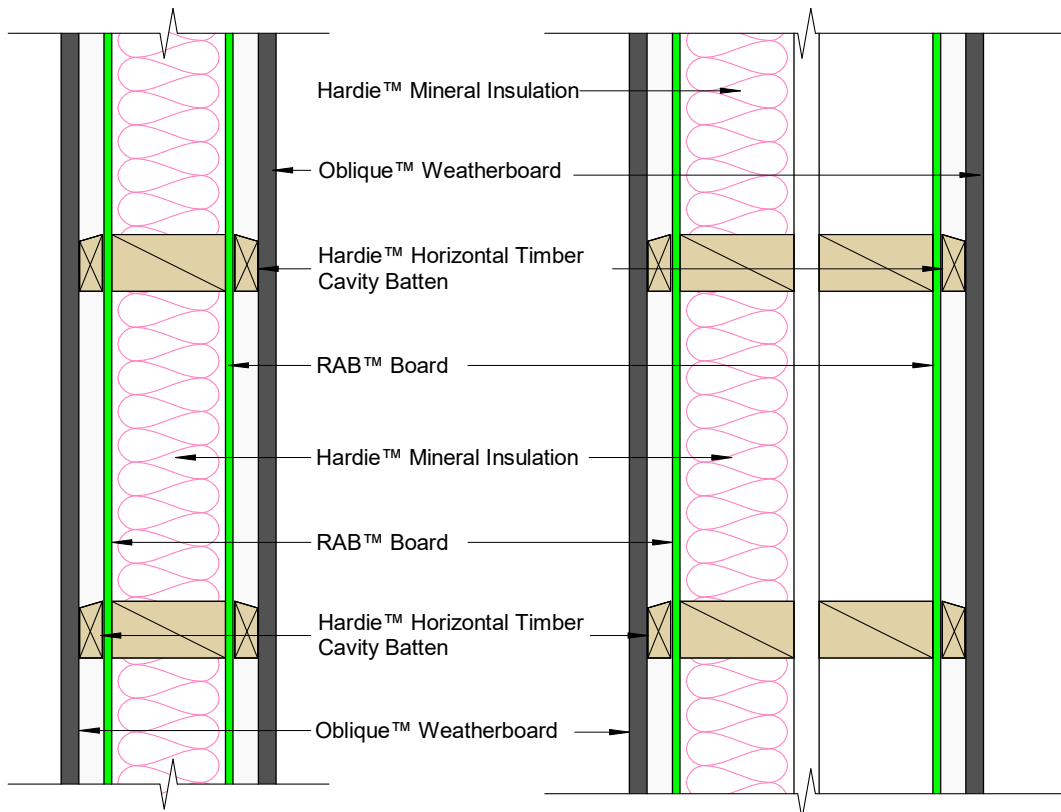

Cladding	Hardie™ Plank Weatherboard	
Framing	Timber framing to be in accordance with NZS 3604 or SED complying with AS/NZS 1170 and NZS 3603. Framing size 90 x 45mm minimum. Studs at 600mm centres and nogs at 800mm centres maximum	Insulation
Cavity Batten	Timber cavity batten nominal 20mm	Underlay
		A flexible underlay that complies with Table C.2.1.1 of E2/AS1 and has a 'flammability index' not exceeding 5 can be used
Cladding Fixing	Cavity Fix: Face fixed with 75 x 3.15mm fibre cement nail to stud	

For further information refer to Hardie™ Plank Weatherboard Technical Specification.

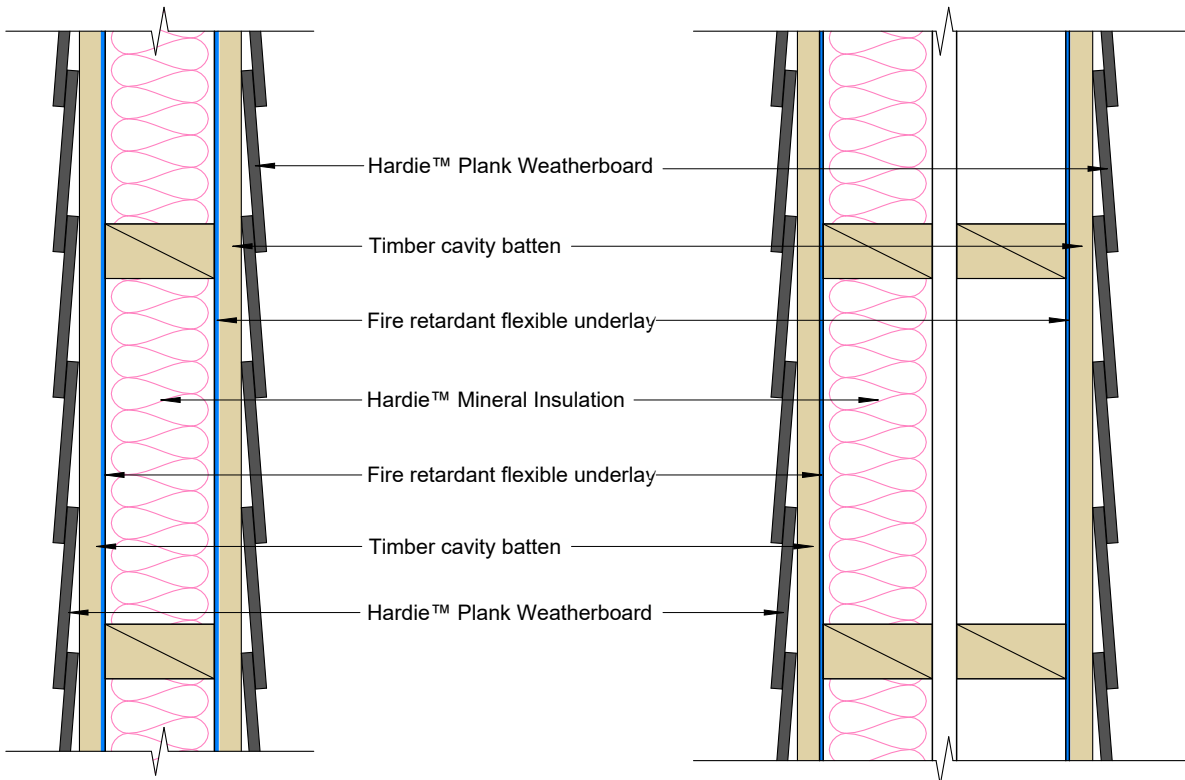

Cladding	Stria™ Cladding Smooth/Fine Texture- Horizontal		
Framing	Timber framing to be in accordance with NZS 3604 or SED complying with AS/NZS 1170 and NZS 3603. Framing size 90 x 45mm minimum. Studs at 600mm centres and nogs at 800mm centres maximum	Insulation	Hardie™ Mineral Insulation
Cavity Batten	Timber cavity batten nominal 20mm	Underlay	A flexible underlay that complies with Table C.2.1.1 of E2/AS1 and has a 'flammability index' not exceeding 5 can be used
Cladding Fixing	Number/type of nails as per Stria™ Cladding Horizontal Installation Technical Specification		

For further information refer to Stria™ Cladding Smooth Horizontal Installation Technical Specification.
Stria™ Cladding Fine Texture Horizontal Installation Technical Specification.

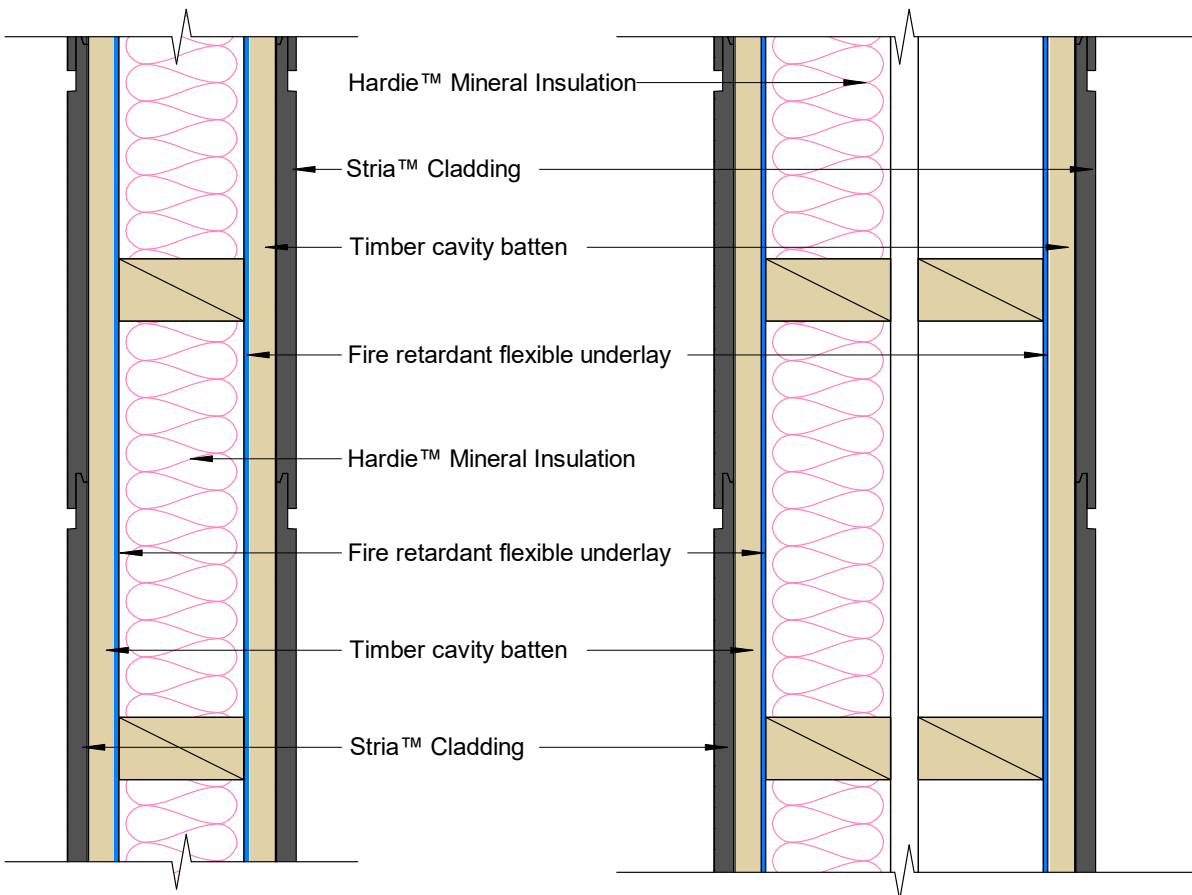

Cladding	Stria™ Cladding Smooth - Horizontal	
Framing	Timber framing to be in accordance with NZS 3604 or SED complying with AS/NZS 1170 and NZS 3603. Framing size 90 x 45mm minimum. Studs at 600mm centres and nogs at 800mm centres maximum	Insulation
Cavity Batten	Timber cavity batten nominal 20mm	Underlay
Cladding Fixing	Number/type of nails as per Stria™ Cladding Smooth Horizontal Installation Technical Specification	
RAB™ Board Fixing	RAB™ Board 6mm: 40 x 2.8mm fibre cement nail at 200mm centres to entire framing RAB™ Board 9mm: 50 x 2.8mm fibre cement nail at 200mm centres to entire framing Fixing to be 12mm from sheet edges	

No cladding required for wall applications enclosed within the roof space.
For further information refer to Stria™ Cladding Smooth Horizontal Installation Technical Specification.

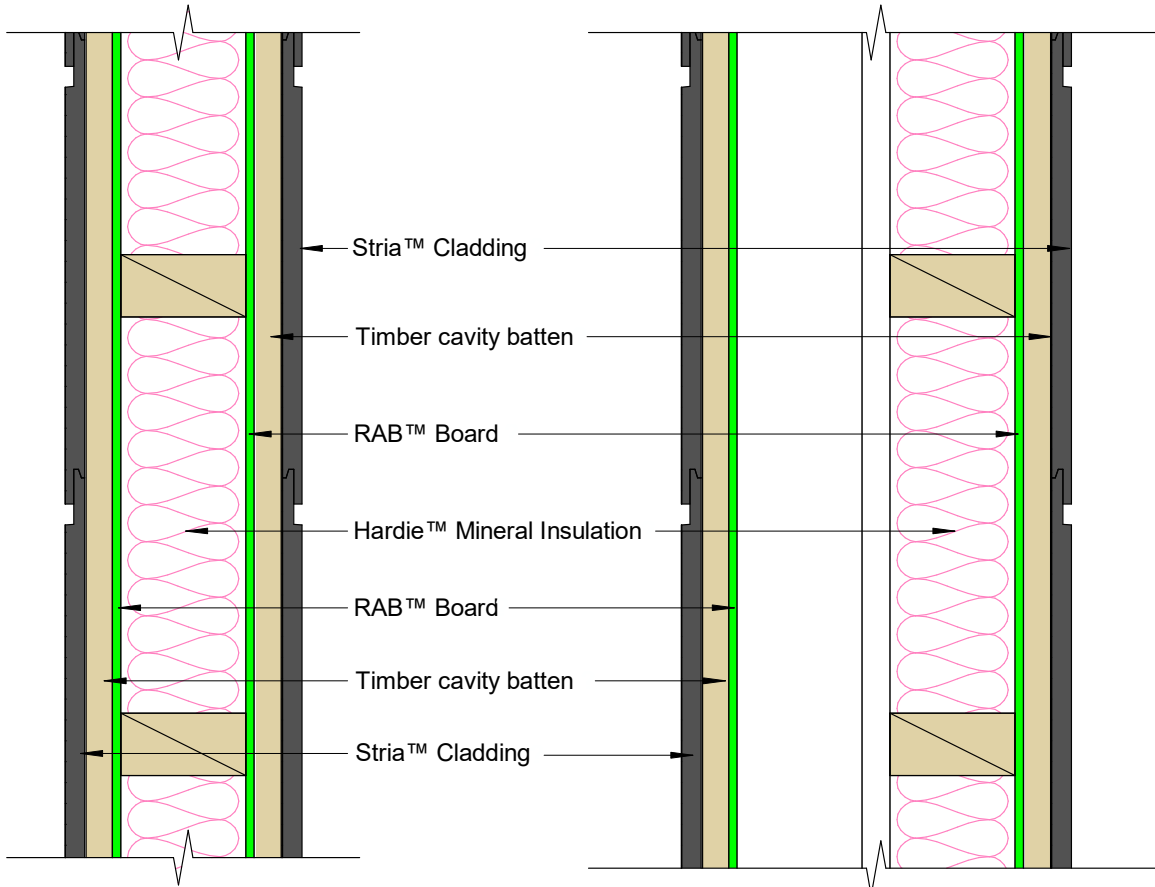

Cladding	Stria™ Cladding Smooth/Fine Texture - Vertical		
Framing	Timber framing to be in accordance with NZS 3604 or SED complying with AS/NZS 1170 and NZS 3603. Framing size 90 x 45mm minimum. Studs at 600mm centres and nogs at centres maximum 800mm for Smooth and 600mm for Fine Texture	Insulation	Hardie™ Mineral Insulation
Cavity Batten	Hardie™ horizontal timber cavity batten 20mm	Underlay	A flexible underlay that complies with Table C.2.1.1 of E2/AS1 and has a 'flammability index' not exceeding 5 can be used
Cladding Fixing	Number/type of nails as per Stria™ Cladding Vertical Installation Technical Specification		

For further information refer to Stria™ Cladding Smooth Vertical Installation Technical Specification.
Stria™ Cladding Fine Texture Vertical Installation Technical Specification.

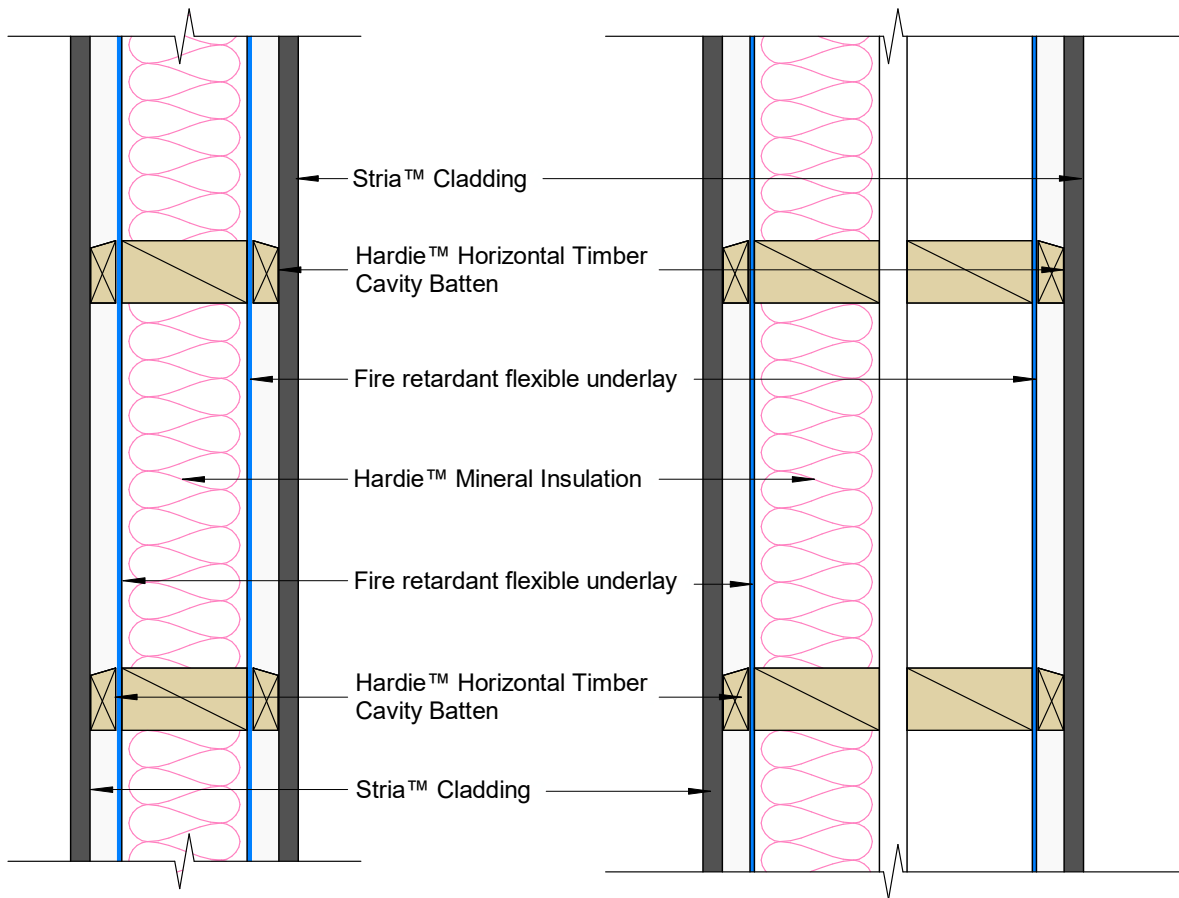

Cladding	Stria™ Cladding Smooth - Vertical		
Framing	Timber framing to be in accordance with NZS 3604 or SED complying with AS/NZS 1170 and NZS 3603. Framing size 90 x 45mm minimum. Studs at 600mm centres and nogs at 800mm centres maximum	Insulation	Hardie™ Mineral Insulation
Cavity Batten	Hardie™ horizontal timber cavity batten 20mm	Underlay	RAB™ Board - Both sides of framing
Cladding Fixing	Number/type of nails as per Stria™ Cladding Smooth Vertical Installation Technical Specification		
RAB™ Board Fixing	RAB™ Board 6mm: 40 x 2.8mm fibre cement nail at 200mm centres to entire framing RAB™ Board 9mm: 50 x 2.8mm fibre cement nail at 200mm centres to entire framing Fixing to be 12mm from sheet edges		

No cladding required for wall applications enclosed within the roof space.
For further information refer to Stria™ Cladding Smooth Vertical Installation Technical Specification.

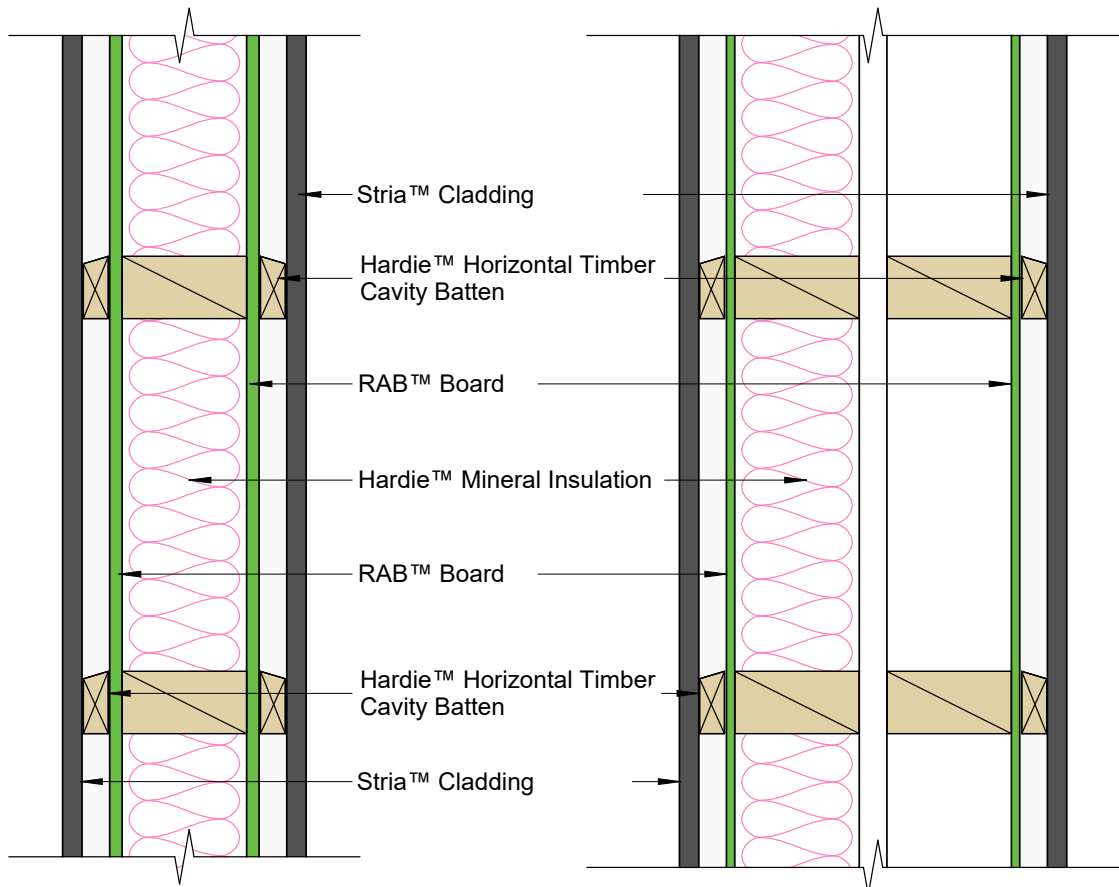

Cladding	Hardie™ Flex Sheet		
Framing	Timber framing to be in accordance with NZS 3604 or SED complying with AS/NZS 1170 and NZS 3603. Framing size 90 x 45mm minimum. Studs at 600mm centres and nogs at 800mm centres maximum	Insulation	Hardie™ Mineral Insulation
Cavity Batten	Timber cavity batten nominal 20mm	Underlay	A flexible underlay that complies with Table C.2.1.1 of E2/AS1 and has a 'flammability index' not exceeding 5 can be used
Cladding Fixing	Direct Fix: 40 x 2.8mm fibre cement nail to stud at 150mm centres to entire frame Cavity Fix: 60 x 2.8mm fibre cement nail to stud at 150mm centres to entire frame		

For further information refer to Hardie™ Flex Sheet Technical Specification.

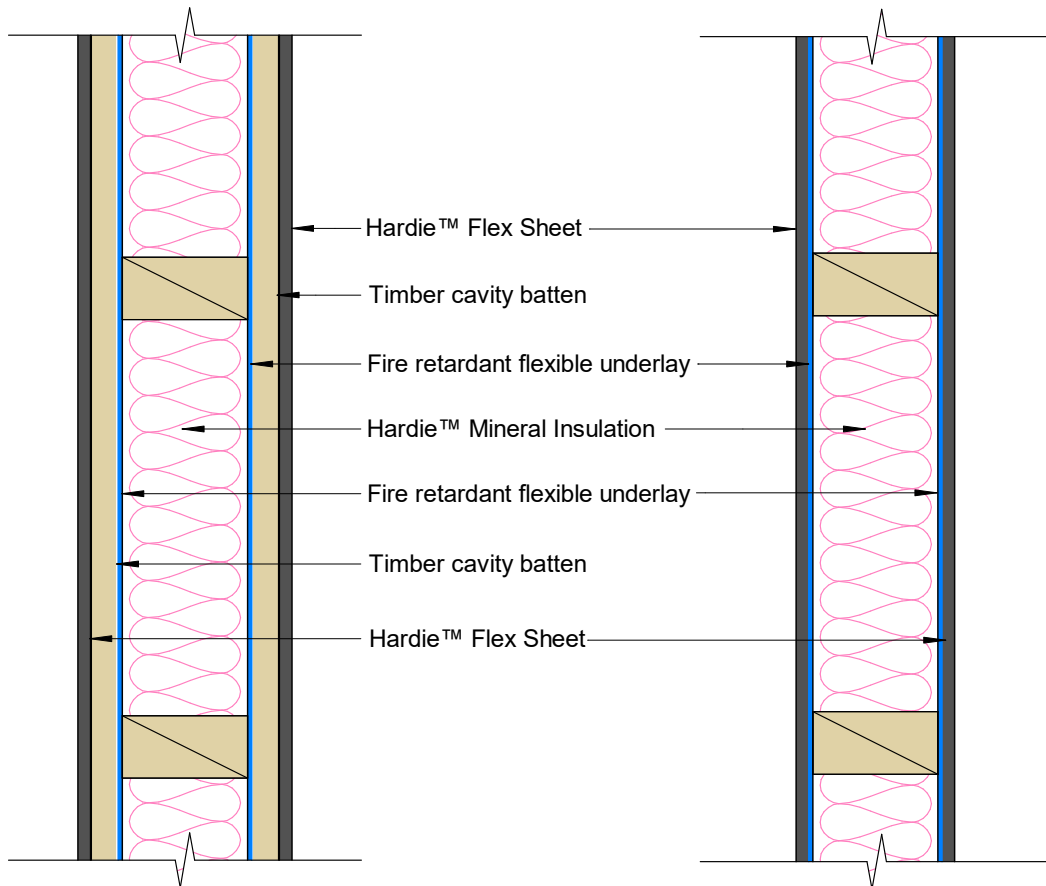

Cladding	Axon™ Panel	
Framing	Timber framing to be in accordance with NZS 3604 or SED complying with AS/NZS 1170 and NZS 3603. Framing size 90 x 45mm minimum. Studs at 600mm centres and nogs at 800mm centres maximum	Insulation
Cavity Batten	Timber cavity batten nominal 20mm	Underlay
Cladding Fixing	Direct Fix: 40 x 2.8mm round head nail at 150mm centres to entire frame Cavity Fix: 60 x 3.15mm round head nail at 150mm centres to entire frame	
		A flexible underlay that complies with Table C.2.1.1 of E2/AS1 and has a 'flammability index' not exceeding 5 can be used

For further information refer to Axon™ Panel Timber Cavity Batten or Direct Fix Technical Specification.

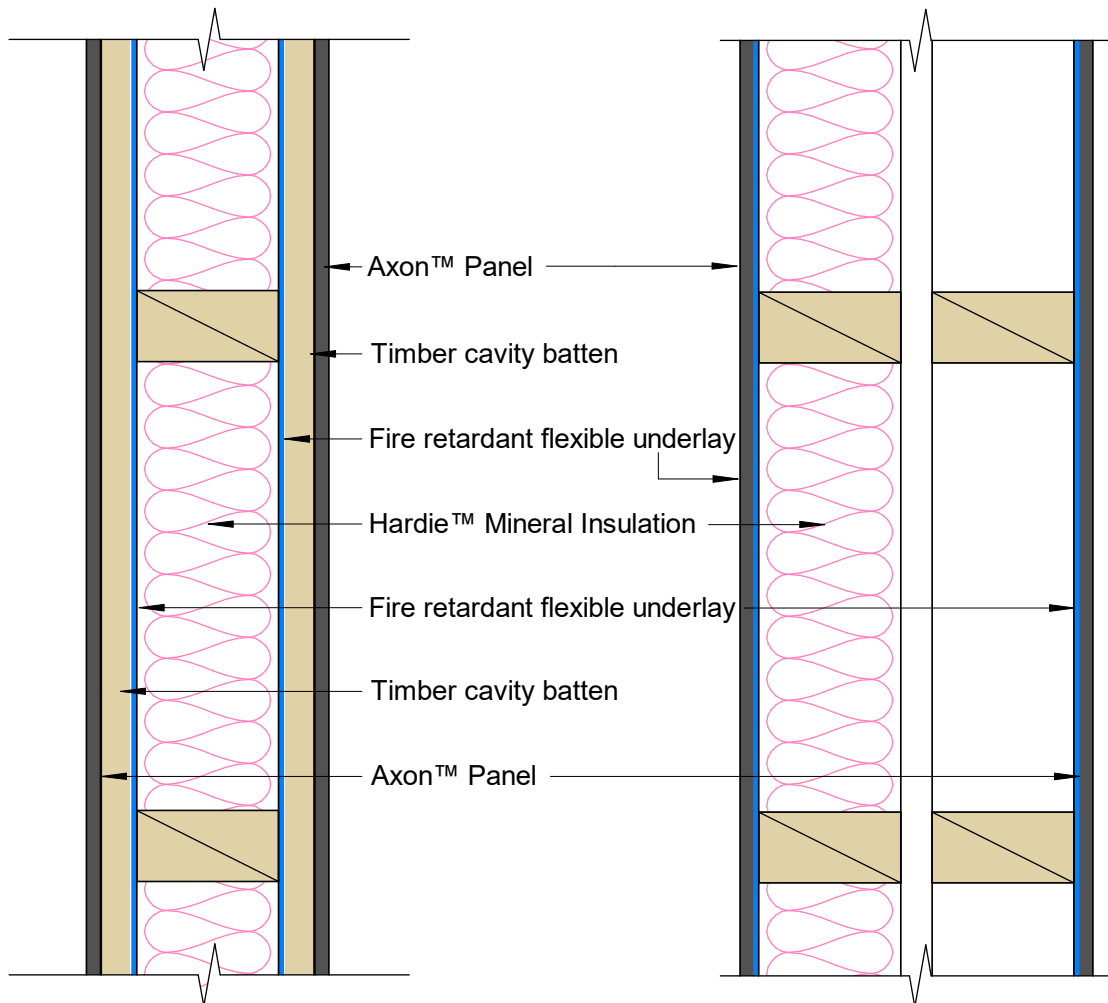

Cladding	Axon™ Panel		
Framing	Timber framing to be in accordance with NZS 3604 or SED complying with AS/NZS 1170 and NZS 3603. Framing size 90 x 45mm minimum. Studs at 600mm centres and nogs at 800mm centres maximum	Insulation	Hardie™ Mineral Insulation
Cavity Batten	Timber cavity batten nominal 20mm	Underlay	RAB™ Board - Both sides of framing
Cladding Fixing	75 x 3.06mm round head nail to 150mm centres to entire frame		
RAB™ Board Fixing	RAB™ Board 6mm: 40 x 2.8mm fibre cement nail at 200mm centres to entire framing RAB™ Board 9mm: 50 x 2.8mm fibre cement nail at 200mm centres to entire framing Fixing to be 12mm from sheet edges		

No cladding required for wall applications enclosed within the roof space.
For further information refer to Axon™ Panel Timber Cavity Batten Technical Specification.
For further information refer to HomeRAB™ Pre-Cladding and RAB™ Board Installation Manual.

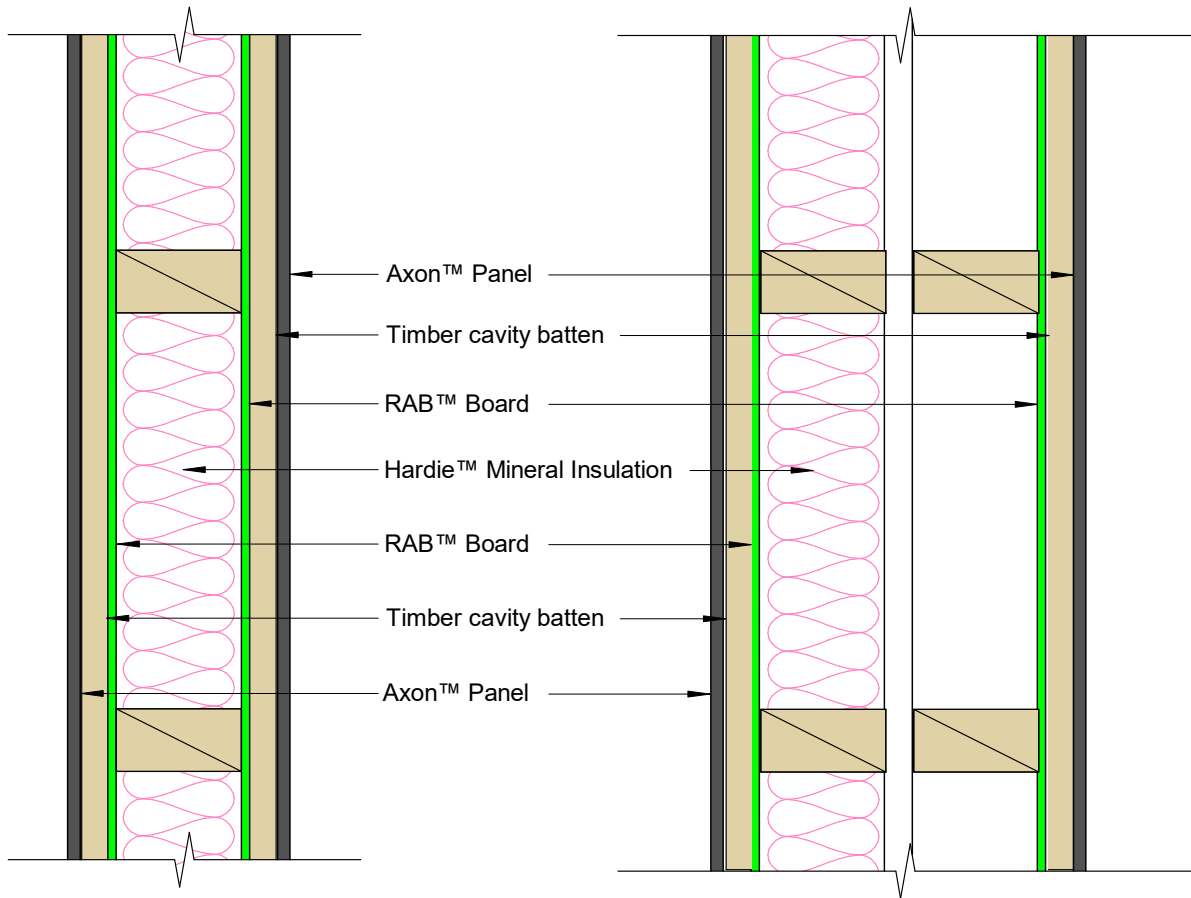

Cladding	Axon™ Panel	
Framing	Timber framing to be in accordance with NZS 3604 or SED complying with AS/NZS 1170 and NZS 3603. Framing size 90 x 45mm minimum. Studs at 600mm centres and nogs at 800mm centres maximum	Insulation
		Hardie™ Mineral Insulation
Cavity Batten	70 x 19mm Hardie™ CLD™ Structural Cavity Batten	Underlay
		RAB™ Board - Both sides of framing
RAB™ Board Fixing	RAB™ Board 6mm: 40 x 2.8mm fibre cement nail at 150mm centres to entire framing RAB™ Board 9mm: 50 x 2.8mm fibre cement nail at 150mm centres to entire framing Fixing to be 12mm from sheet edges	
Cladding Fixing	As per Axon™ Panel Fixed to Hardie™ CLD™ Structural Cavity Batten Technical Specification	

No cladding required for wall applications enclosed within the roof space.
For further information refer to HomeRAB™ Pre-Cladding and RAB™ Board Installation Manual.

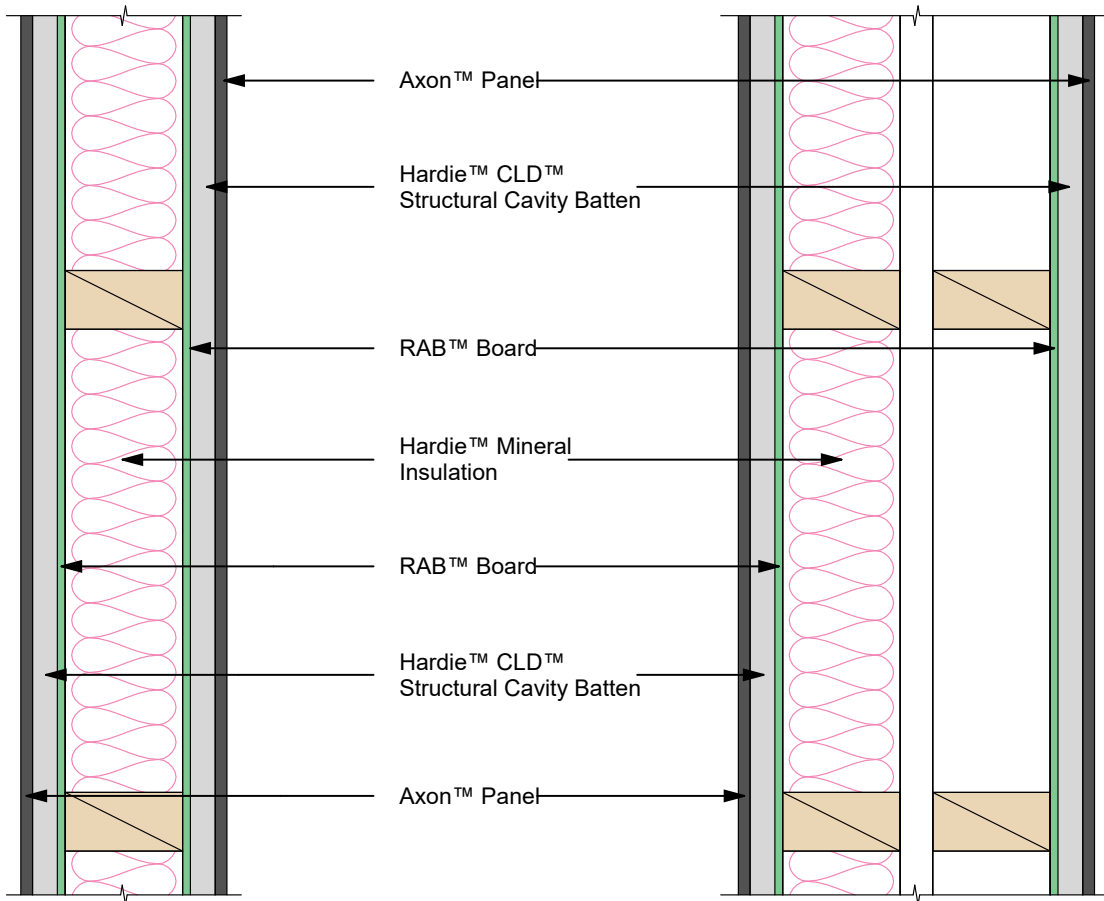

Cladding	ExoTec™ Facade Panel - Top Hat System		
Framing	Timber framing to be in accordance with NZS 3604 or SED complying with AS/NZS 1170 and NZS 3603. Framing size 90 x 45mm minimum. Studs at 600mm centres and nogs at 800mm centres maximum	Insulation	Hardie™ Mineral Insulation
Cavity Batten	ExoTec™ Top Hat System	Underlay	RAB™ Board - Both sides of framing
RAB™ Board Fixing	6mm RAB™ Board: 40 x 2.8mm fibre cement nail at 150mm centres to entire framing 9mm RAB™ Board: 50 x 2.8mm fibre cement nail at 150mm centres to entire framing Fixing to be 12mm from sheet edges		
Cladding Fixing	As per ExoTec™ Facade Panel Top Hat Technical Specification		

No cladding required for wall applications enclosed within the roof space.
For further information refer to HomeRAB™ Pre-Cladding and RAB™ Board Installation Manual.

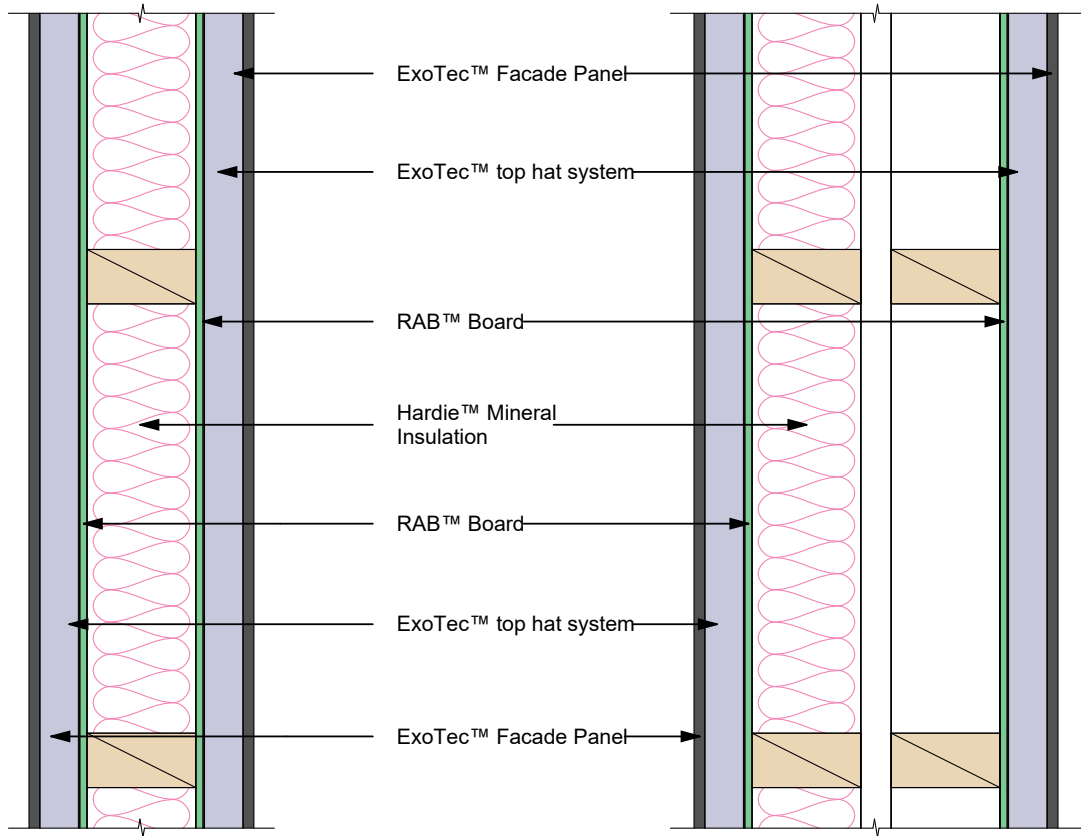

Cladding	Cladding system as per Table 5.3.1.1 of C/AS1 and Table 8.4.1.2 of Building Product Specifications	Insulation	Hardie™ Mineral Insulation
Framing	Timber framing to be in accordance with NZS 3604 or SED complying with AS/NZS 1170 and NZS 3603. Framing size 90 x 45mm minimum. Studs at 600mm centres and nogs at 800mm centres maximum	Underlay	RAB™ Board - Both sides of framing
Cavity Batten	As per cladding manufacturer technical specification		
RAB™ Board Fixing	RAB™ Board 6mm: 40 x 2.8mm fibre cement nail at 150mm centres to entire framing RAB™ Board 9mm: 50 x 2.8mm fibre cement nail at 150mm centres to entire framing Fixing to be 12mm from sheet edges		
Cladding Fixing	As per cladding manufacturer technical specification		

No cladding required for wall applications enclosed within the roof space.
For further information refer to HomeRAB™ Pre-Cladding and RAB™ Board Installation Manual.

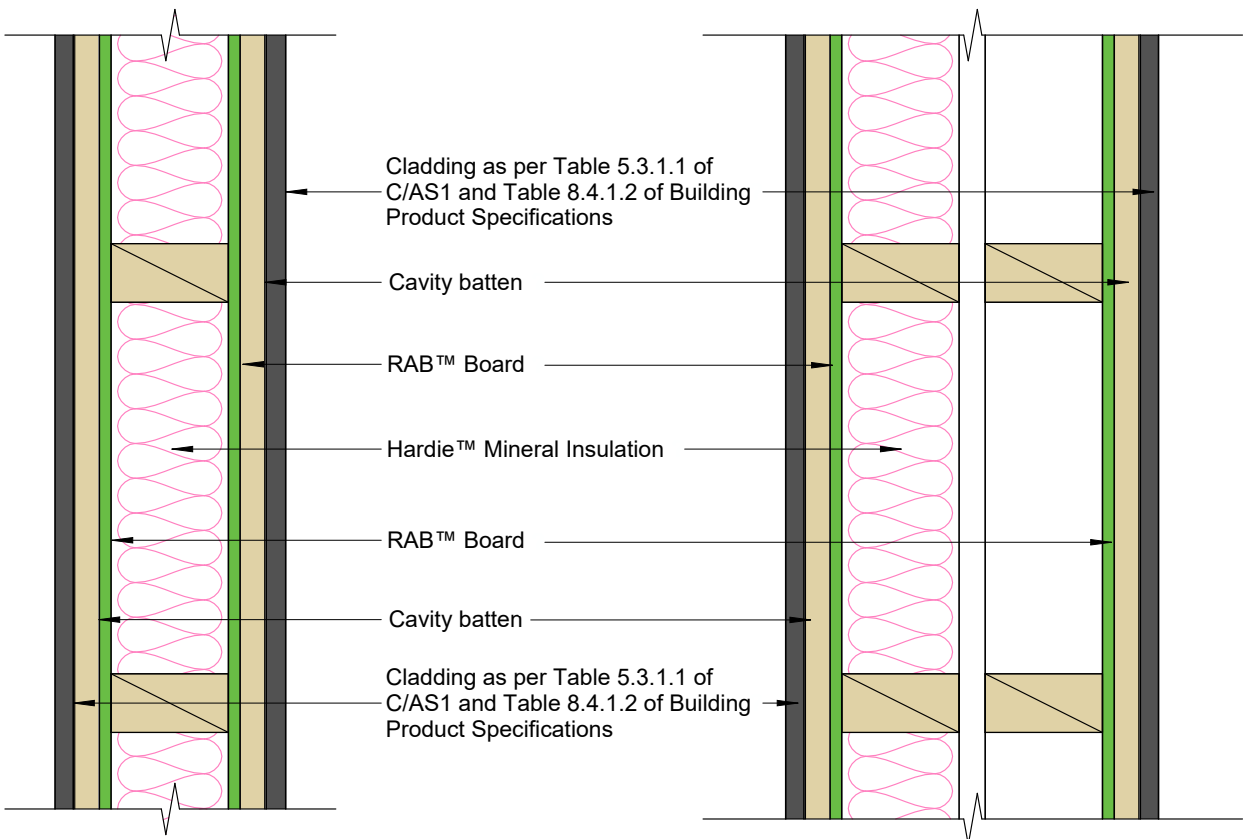

Internal Walls Timber Frame

30 Minute Fire Rated System

60 Minute Fire Rated System

Lining	Villaboard™ Lining 6 or 9mm	Lining	10mm GIB Fyreline®
Framing	Timber framing to be in accordance with NZS 3604 or SED complying with AS/NZS 1170 and NZS 3603. Framing size 90 x 45mm minimum. Studs at 600mm centres and nogs at 800mm centres maximum	Insulation	Glass wool insulation 90mm thick, R2.2 or higher.
Lining Fixing	Fix Villaboard™ Lining with Villadrive™ 30mm x 7g wood screw or 40 x 2.8mm fibre cement nail at 150mm maximum centres	Lining Fixing	Fix GIB Fyreline® with 41mm x 6g GIB® Grabber® High Thread Drywall Screws 300mm centre around the sheet perimeter and intermediate studs Fixing to be 12mm from bound sheet edges and 18mm from sheet ends

For further information refer to Villaboard™ Lining Installation Manual.

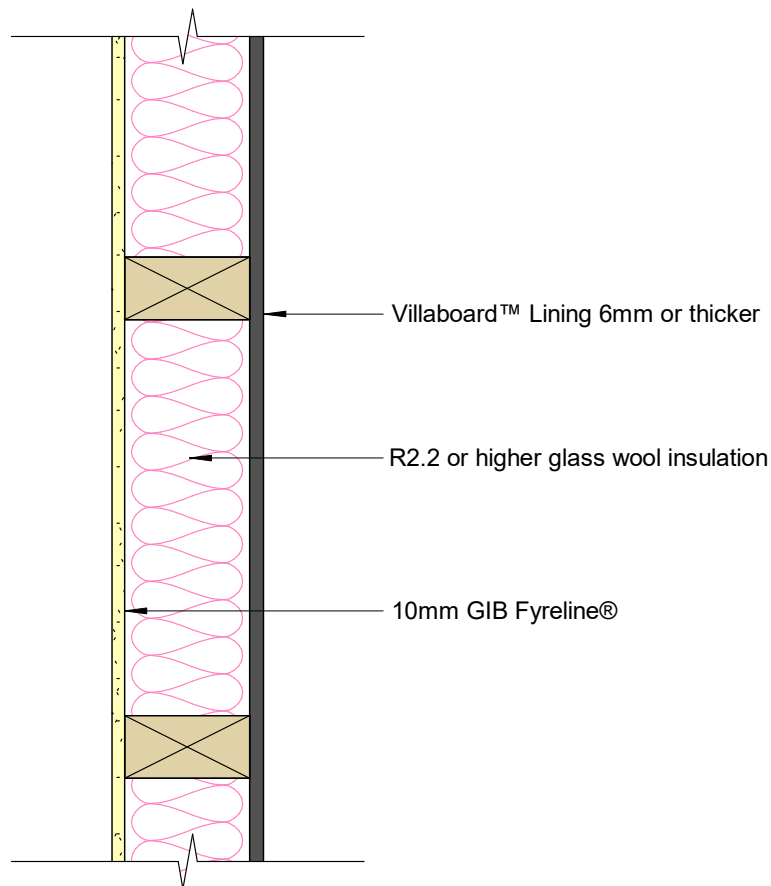

Lining	Villaboard™ Lining 6 or 9mm	Lining	13mm GIB Fyreline®
Framing	Timber framing to be in accordance with NZS 3604 or SED complying with AS/NZS 1170 and NZS 3603. Framing size 90 x 45mm minimum. Studs at 600mm centres and nogs at 800mm centres maximum	Insulation	Hardie™ Mineral Insulation
Lining Fixing	Fix Villaboard™ Lining with Villadrive™ 30mm x 7g wood screw or 40 x 2.8mm fibre cement nail at 150mm maximum centres	Lining Fixing	Fix GIB Fyreline® with 41mm x 6g GIB® Grabber® High Thread Drywall Screws 300mm centre around the sheet perimeter and intermediate studs Fixing to be 12mm from bound sheet edges and 18mm from sheet ends

For further information refer to Villaboard™ Lining Installation Manual.

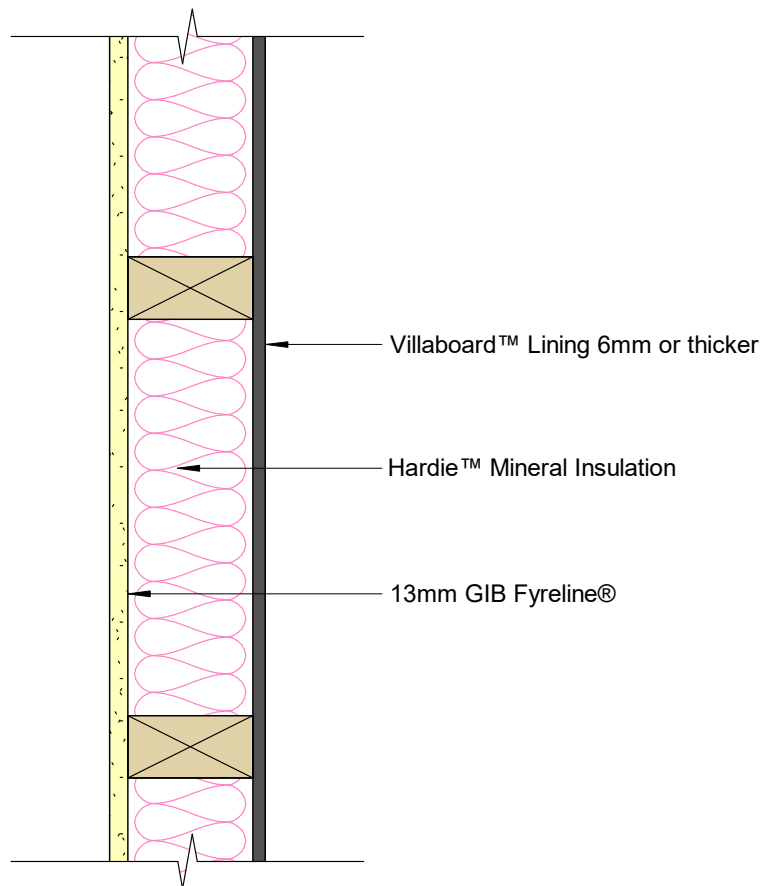

Lining	Villaboard™ Lining 6 and 9mm	
Framing	Timber framing to be in accordance with NZS 3604 or SED complying with AS/NZS 1170 and NZS 3603. Framing size 90 x 45mm minimum. Studs at 600mm centres and nogs at 800mm centres maximum. For intertenancy walls double frame with 25mm gap between frames.	Insulation 1 layer of Hardie™ Mineral Insulation 1 layer of Glass wool insulation 90mm thick, R2.2 or higher
Lining Fixing	Fix Villaboard™ Lining with Villadrive™ 30mm x 7g wood screw or 40 x 2.8mm fibre cement nail at 150mm maximum centres	

*STC value for IT wall.

For further information refer to Villaboard™ Lining Installation Manual.

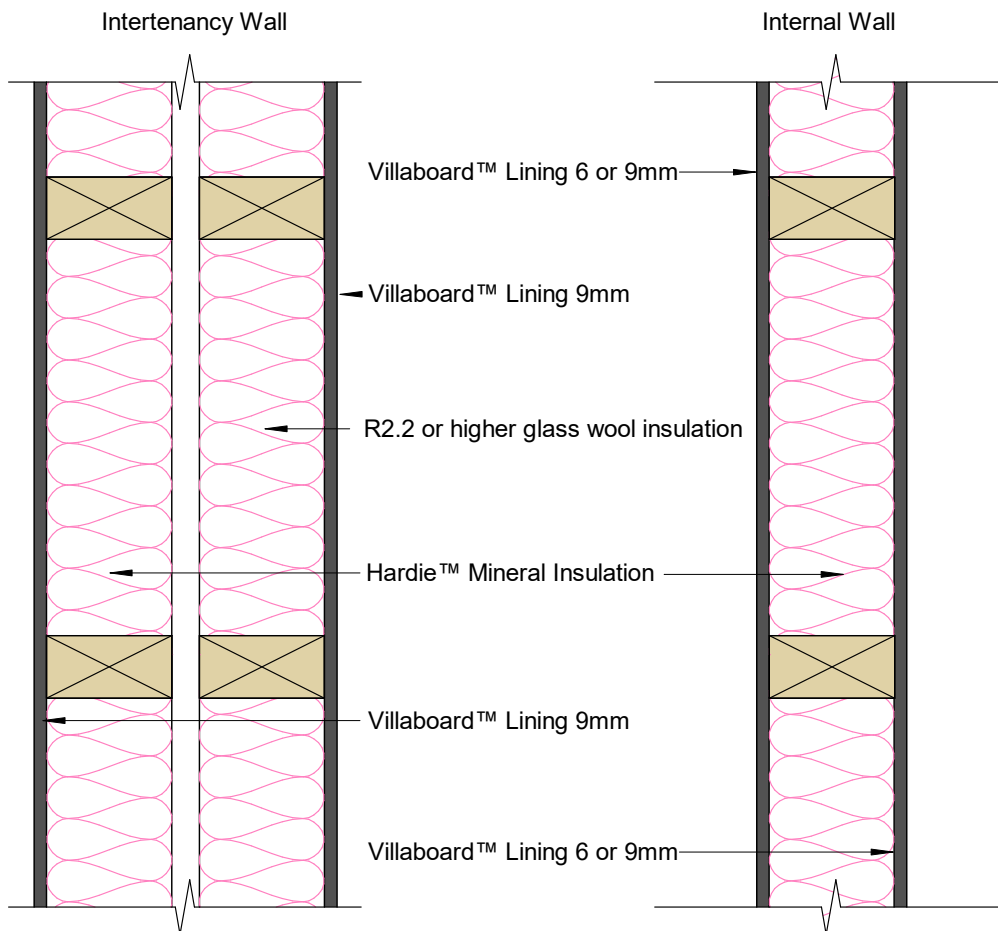

Lining	Villaboard™ Lining 6 and 9mm	
Framing	Timber framing to be in accordance with NZS 3604 or SED complying with AS/NZS 1170 and NZS 3603. Framing size 90 x 45mm minimum. Studs at 600mm centres and nogs at 800mm centres maximum. For intertenancy walls double frame with 25mm gap between frames.	Underlay RAB™ Board
Lining Fixing	Fix Villaboard™ Lining with Villadrive™ 30mm x 7g wood screw or 40 x 2.8mm fibre cement nails at 150mm maximum centres	
RAB™ Board Fixing	RAB™ Board 6mm: 40 x 2.8mm fibre cement nail at 150mm centres to entire framing RAB™ Board 9mm: 50 x 2.8mm fibre cement nail at 150mm centres to entire framing Fixing to be 12mm from sheet edges	

*STC value for IT wall

For further information refer to Villaboard™ Lining Installation Manual.

For further information refer to HomeRAB™ Pre-Cladding and RAB™ Board Installation Manual.

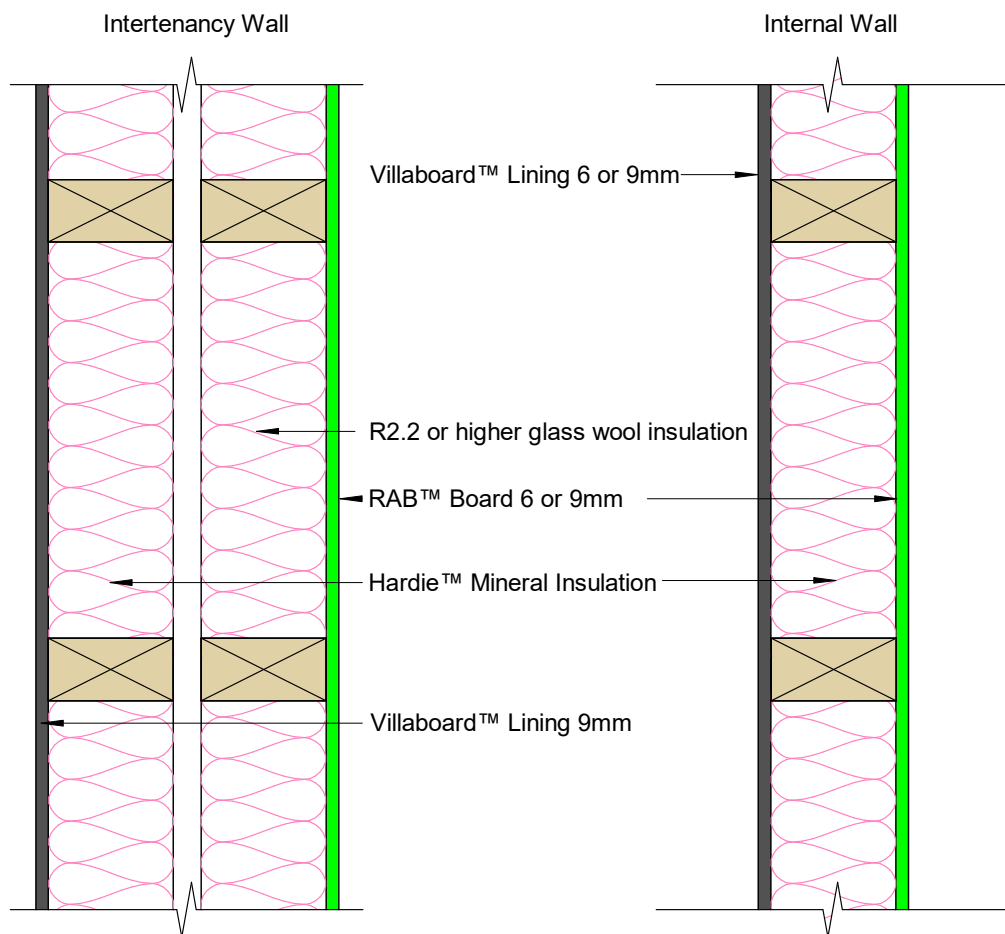

Internal Floors/Ceilings Timber Frame

60 Minute Fire Rated System

Ceiling	2 x 13mm GIB Fyreline®	
Joist	Joist to be in accordance with NZS 3604 or SED complying with AS/NZS 1170 and NZS 3603. Joist size 190 x 45mm minimum. Joist spacing 400mm centres maximum. HySPAN and hyJOIST series joists can also be used in accordance with SED, meeting the requirements of AS/NZS 1170.	Insulation Glass wool insulation 75mm thick minimum
Flooring	Secura™ Flooring	
Secura™ Flooring	<p>First Layer: 50 x 2.8mm round head nails at 200mm centres 25mm minimum distance from tongue and groove 12mm minimum edge distance</p> <p>Second Layer: Hardie™ Acoustic Cradles at 450mm centres. Hardie™ Acoustic Floor Channels at 400mm centres placed over acoustic cradles Second layer of Secura™ Flooring fitted with 40-45mm x 8-10g self embedding steel screws at 200mm centres into Hardie™ Acoustic Floor Channel 25mm minimum distance from tongue and groove 12mm minimum edge distance at short panel edges Ensure the floor is level before laying the Cradles. Shims can be used under the Cradles to pack, if needed.</p>	
Ceiling to GIB Quiet Clip®	<p>Inner layer: 32mm x 6g GIB® Grabber® Drywall Self Tapping Screws Outer layer: 41mm x 6g GIB® Grabber® Drywall Self Tapping Screws 200mm centres along each batten and at 100mm centres along sheet end butt joints Place fasteners no closer than 12mm to the sheet edges</p>	

For further information refer to Secura™ Flooring Fire Acoustic Floor System Installation Manual.

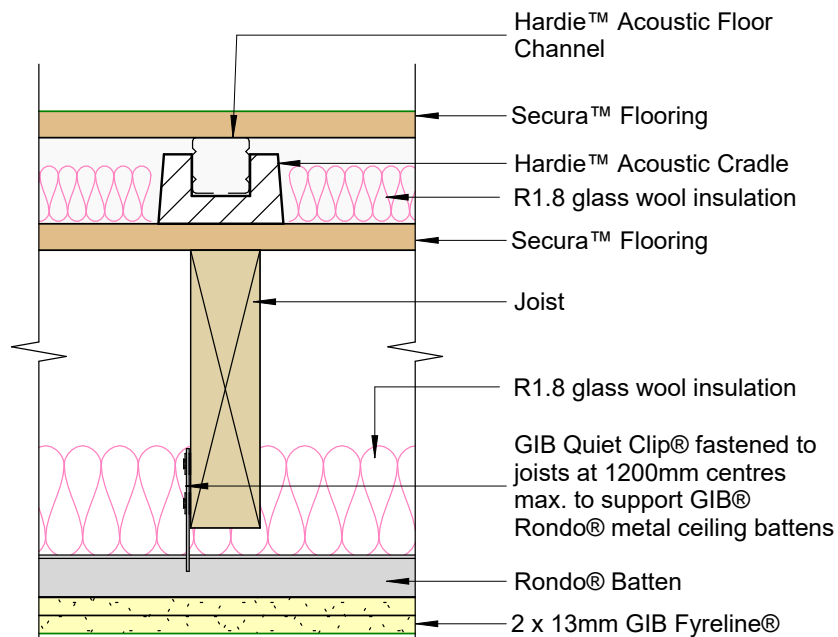

5 Construction details

Construction details are available for download at www.jameshardie.co.nz

Table 1

Description	Page
Figure 1: Thermal Fire Batten Fixing	14
Figure 2: SED project post fire stability – Slab on ground foundation	81
Figure 3: SED project post fire stability – Blockwall foundation	82
Figure 4: SED project post fire stability – Timber Joists at right angles to wall	83
Figure 5: SED project post fire stability - Timber Joists parallel to wall	84
Figure 6: Fire rated boundary wall with soffit	85
Figure 7: Fire rated boundary wall with barge soffit	86
Figure 8: Fire rated boundary wall nil soffit	87
Figure 9: Sub-floor fire rated wall	88
Figure 10: Fire cell extension	89
Figure 11: Beam Penetration in FRR wall	90
Figure 12: Intertenancy Wall Multi-Story Detail on Concrete Foundation	91
Figure 13: Intertenancy Wall Multi-Story Detail on Timber Foundation	92
Figure 14: Wing wall – Linea™ Weatherboard	93
Figure 15: Wing wall RAB™ Board	94
Figure 16: Control joint detail – Linea™ Weatherboard	95
Figure 17: Vertical central joint detail	96
Figure 18: Intertenancy fire separation - over 10m building height	97
Figure 19: Timber floor to floor intertenancy wall junction	98
Figure 20: Concrete floor to floor intertenancy wall junction	99
Figure 21: Penetration detail – Switch box	100
Figure 22: Penetration detail – HDPE/PEX/PEX-AL-PEX pipe, flexible underlay	101
Figure 23: Penetration detail – uPVC pipe, flexible underlay	102
Figure 24: Penetration detail – uPVC pipe, RAB™ Board	103
Figure 25: Penetration detail – Electrical cable /Copper pipe	104
Figure 26: Penetration detail – HDPE/PEX pipe, RAB™ Board	105

Figure 2: SED project post fire stability – Slab on ground foundation

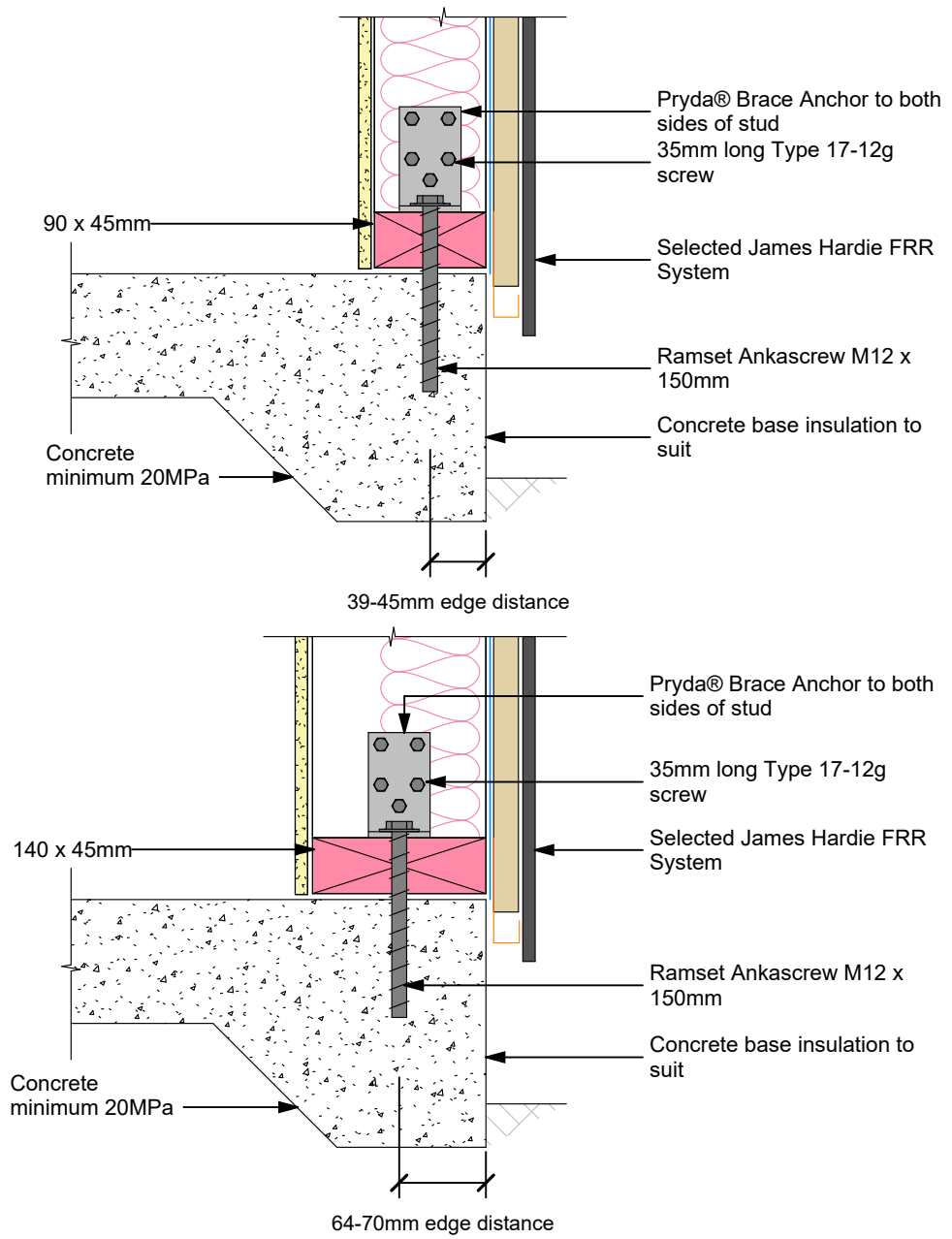

Wall height max (mm)	2400	3000	3000	3700
Stud bottom plate (mm)	90 x 45	90 x 45	140 x 45	140 x 45
Stud spacing max (mm)	400	300	600	400
Nog spacing max (mm)	800	800	800	800
Hold down brackets	Pryda® Brace / GIB Handibrac® Anchor both sides of stud			

For higher stud heights, please refer to James Hardie
Alternatively, the post fire stability design can be as per SED by the project engineer

Figure 3: SED project post fire stability – Blockwall foundation

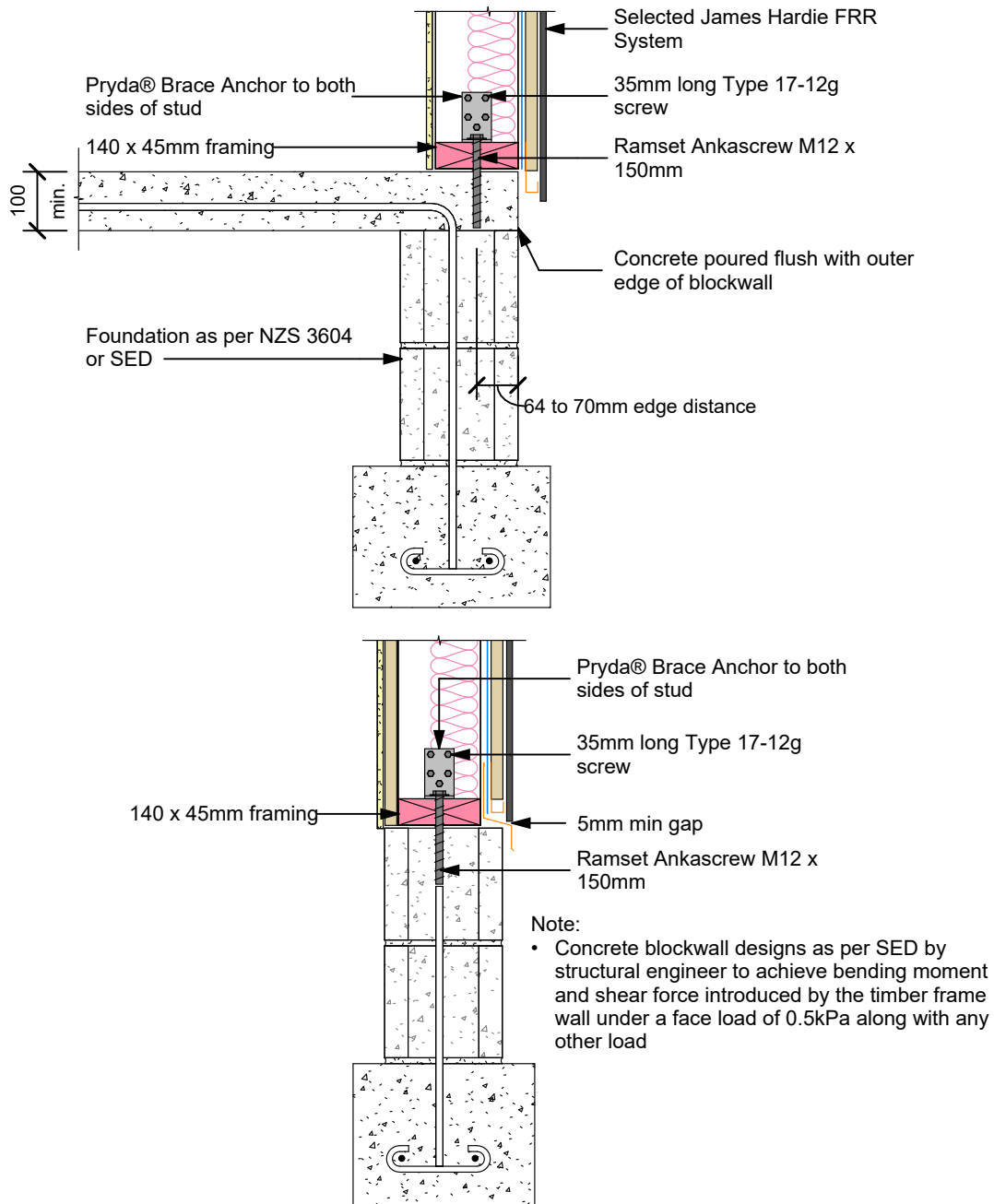

Wall height max (mm)	3000	3700
Stud bottom plate (mm)	140 x 45	140 x 45
Stud spacing max (mm)	600	400
Nog spacing max (mm)	800	800
Hold down brackets	Pryda® Brace / GIB Handibrac® Anchor both sides of stud	

For higher stud heights, please refer to James Hardie
Alternatively, the post fire stability design can be as per SED by the project engineer

Figure 4: SED project post fire stability – Timber Joists at right angles to wall

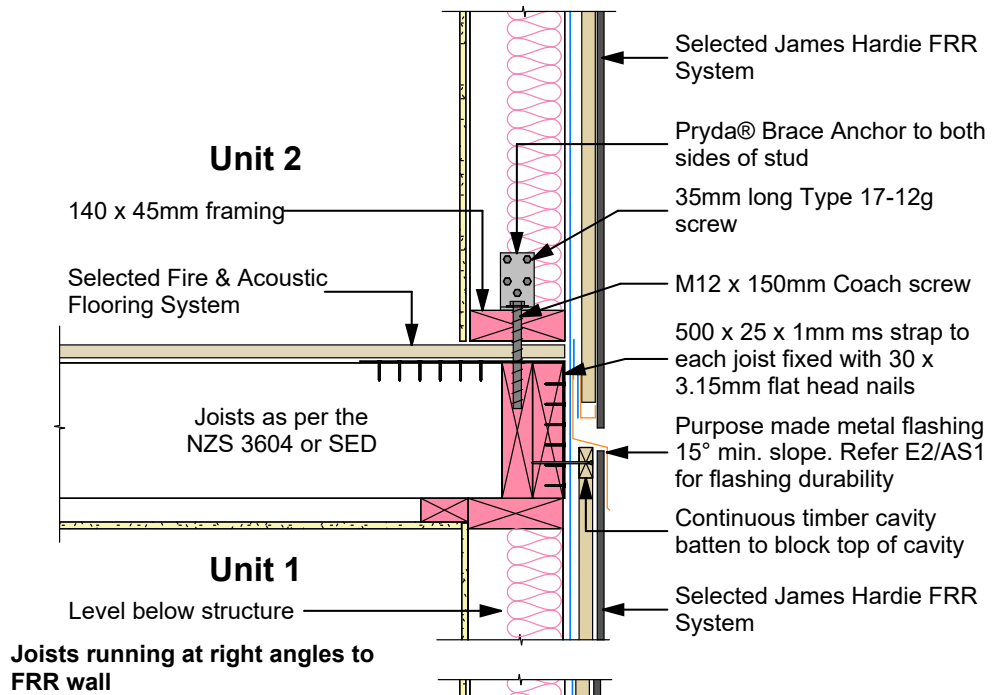

Joists running at right angles to FRR wall

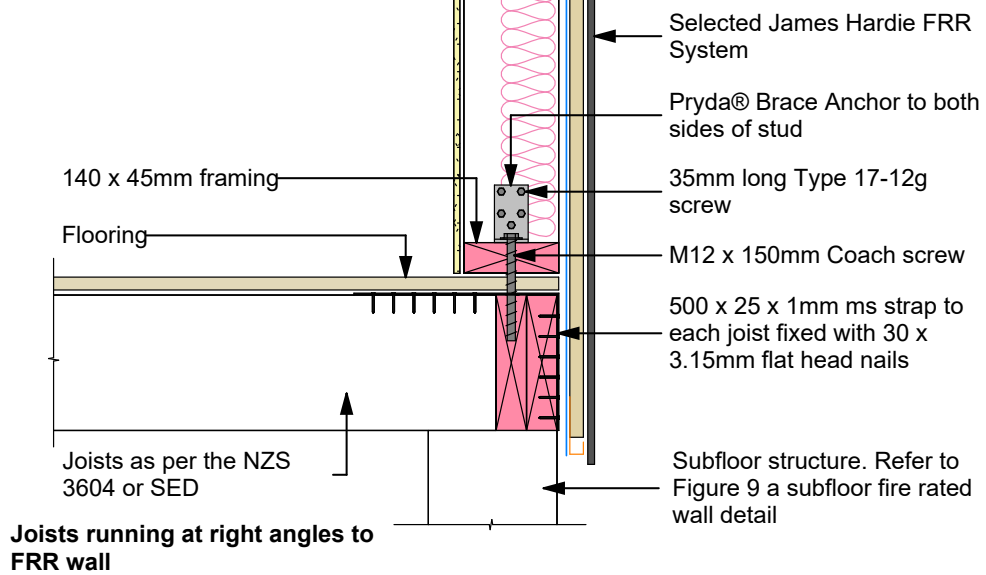

Joists running at right angles to FRR wall

	Joist at right angle to boundary joist		
Stud bottom plate size (mm)	140 x 45	140 x 45	140 x 45
Stud spacing max (mm)	600	400	300
Nog spacing max (mm)	800	800	800
Hold down brackets	Pryda® Brace / GIB Handibrac® Anchor both sides of stud		
Wall height max (mm)	2600	3000	3700
Joist min (mm)	190	190	190

For higher stud heights, please refer to James Hardie
Alternatively, the post fire stability design can be as per SED by the project engineer

Figure 5: SED project post fire stability - Timber Joists parallel to wall

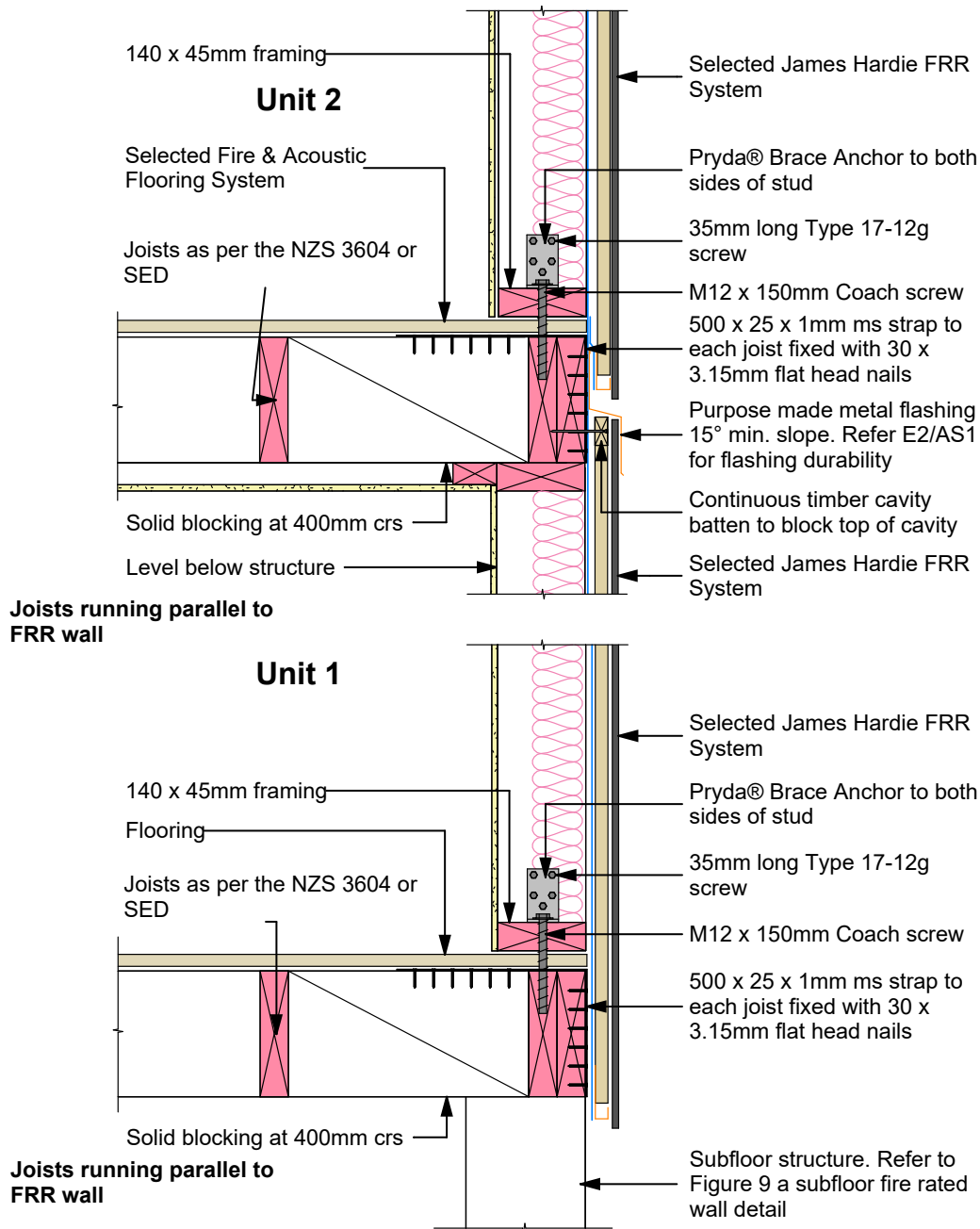

	Joist parallel to boundary joist
Stud/ Bottom plate size (mm)	140 x 45
Stud spacing max (mm)	600
Nog spacing max (mm)	800
Hold down brackets	Pryda® Brace Anchor / GIB Handibrac® Anchor both sides of stud
Wall height max (mm)	2700
Joist min (mm)	190

For higher stud heights, please refer to James Hardie
Alternatively, the post fire stability design can be as per SED by the project engineer

Figure 6: Fire rated boundary wall with soffit

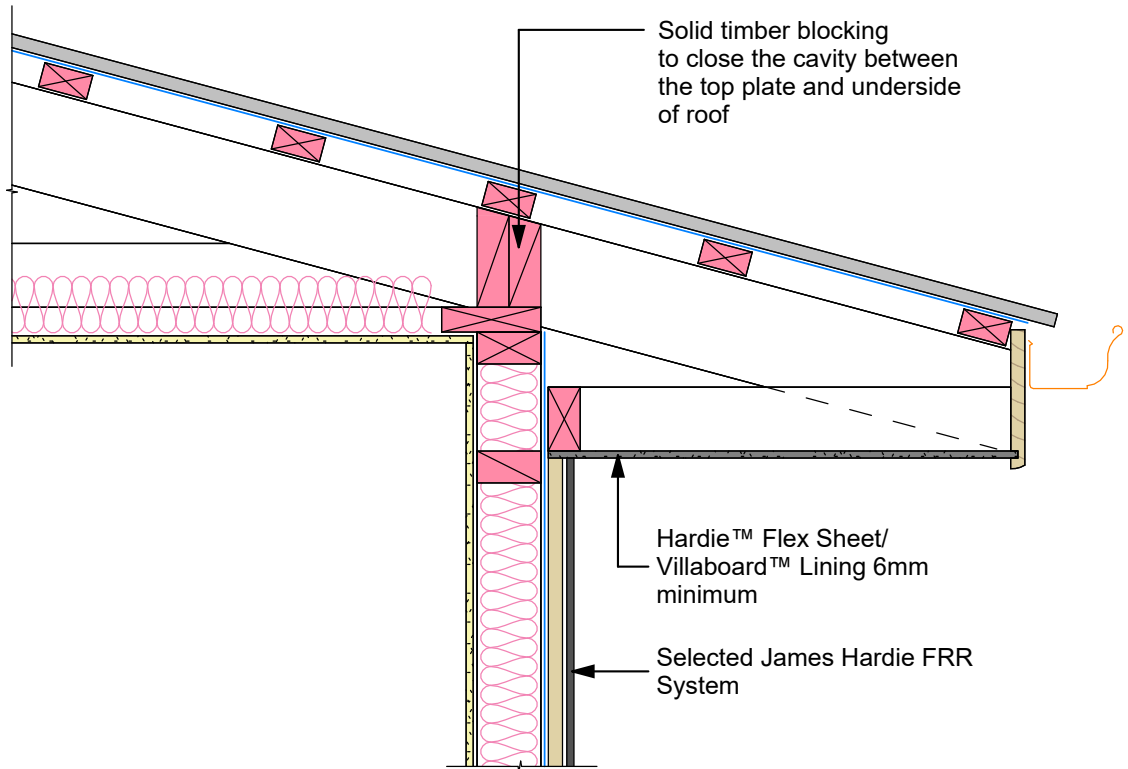

Figure 7: Fire rated boundary wall with barge soffit

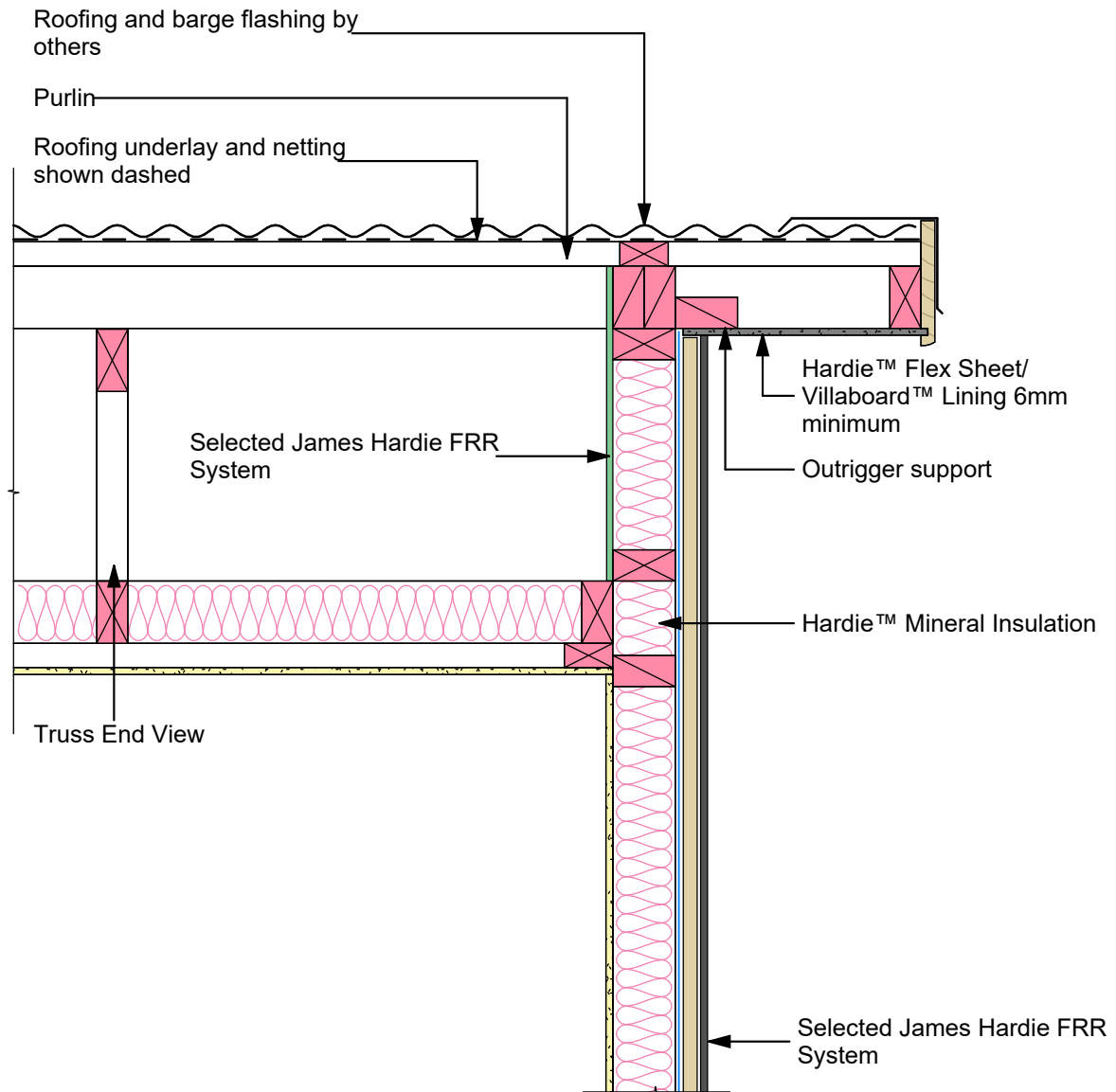

Figure 8: Fire rated boundary wall nil soffit

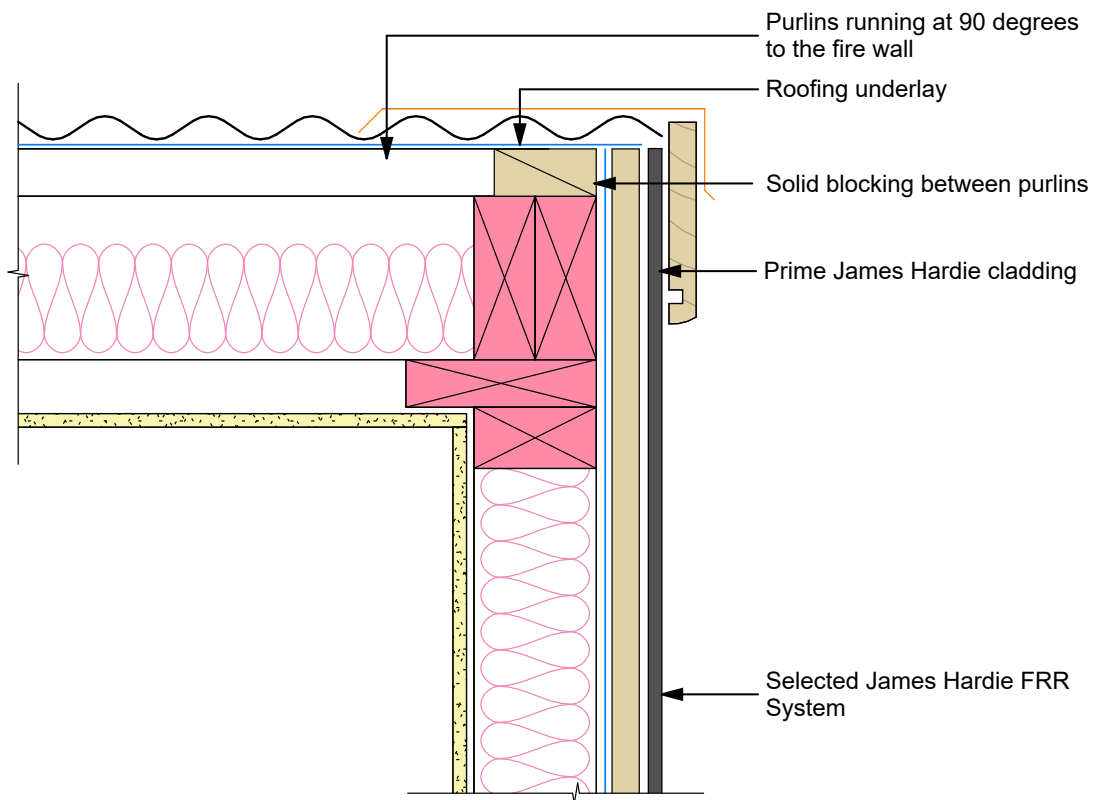
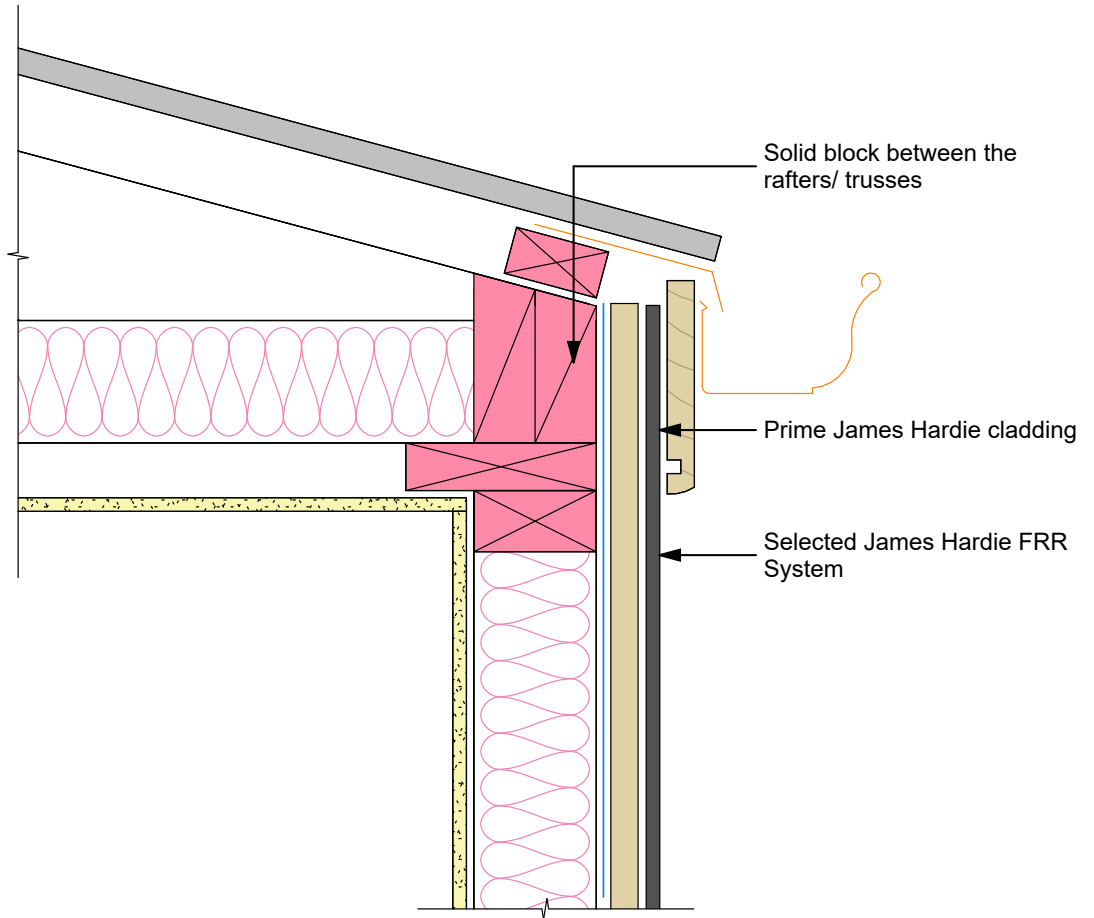

Figure 9: Sub-floor fire rated wall

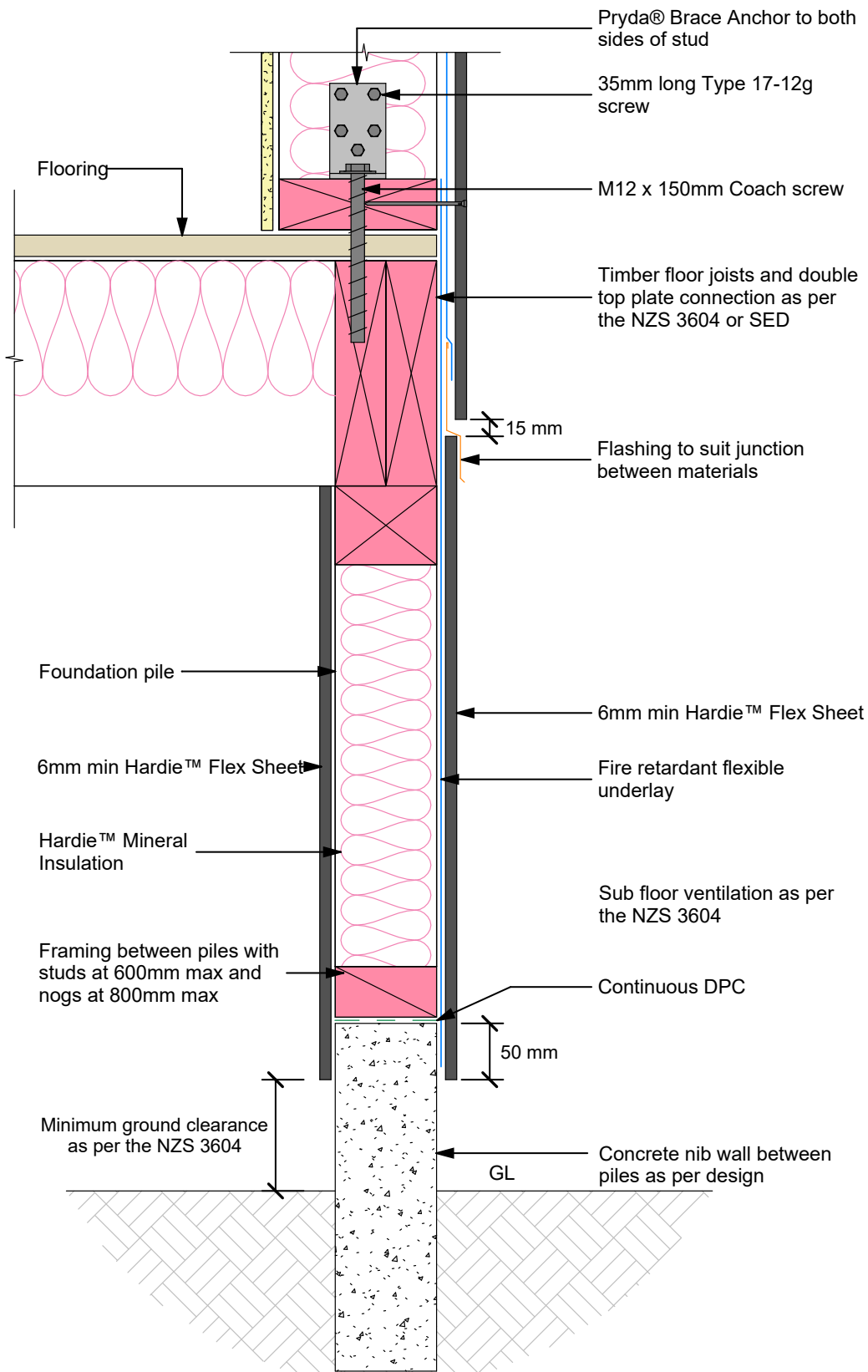

Figure 10: Fire cell extension

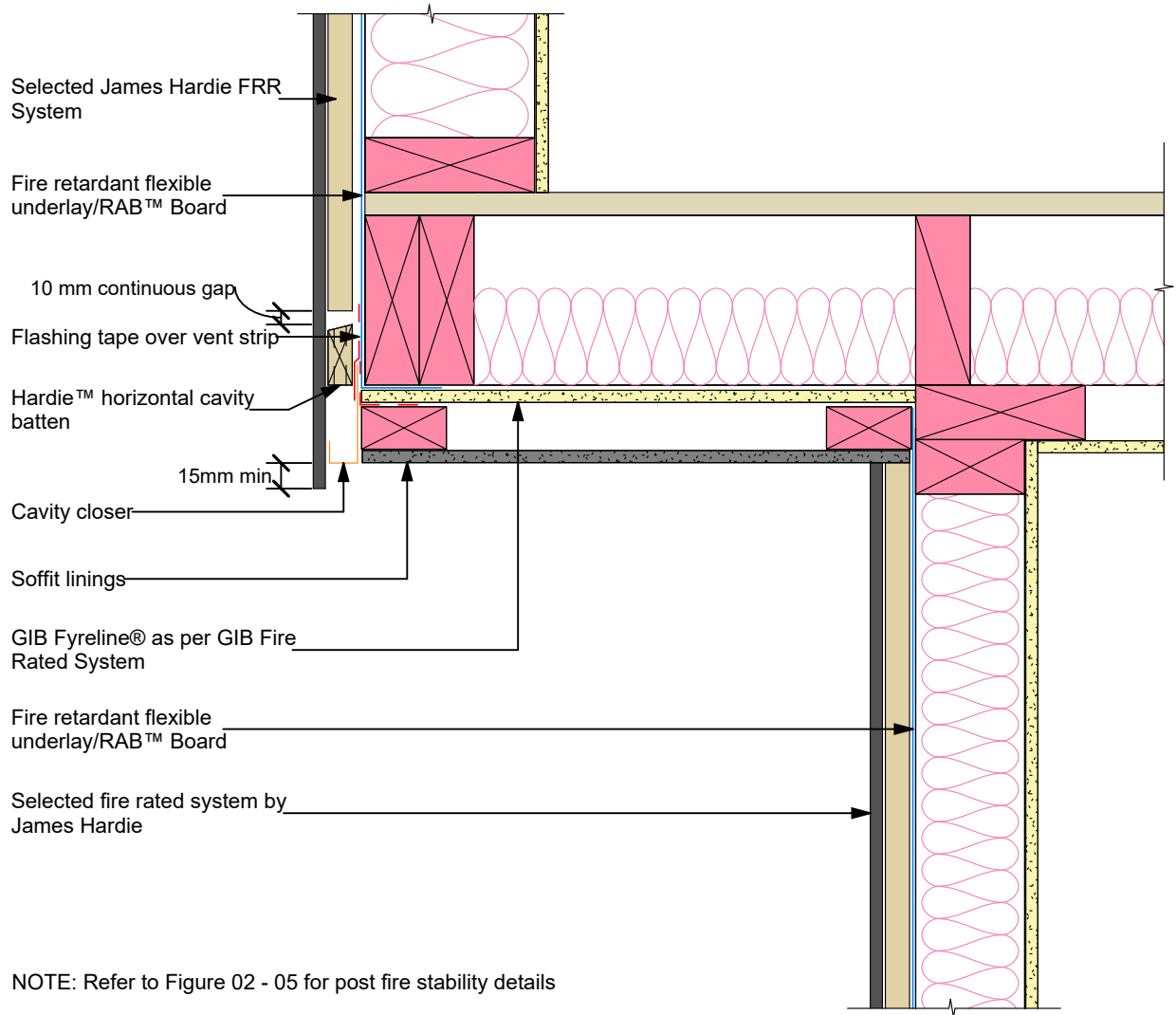

Figure 11: Beam Penetration in FRR wall

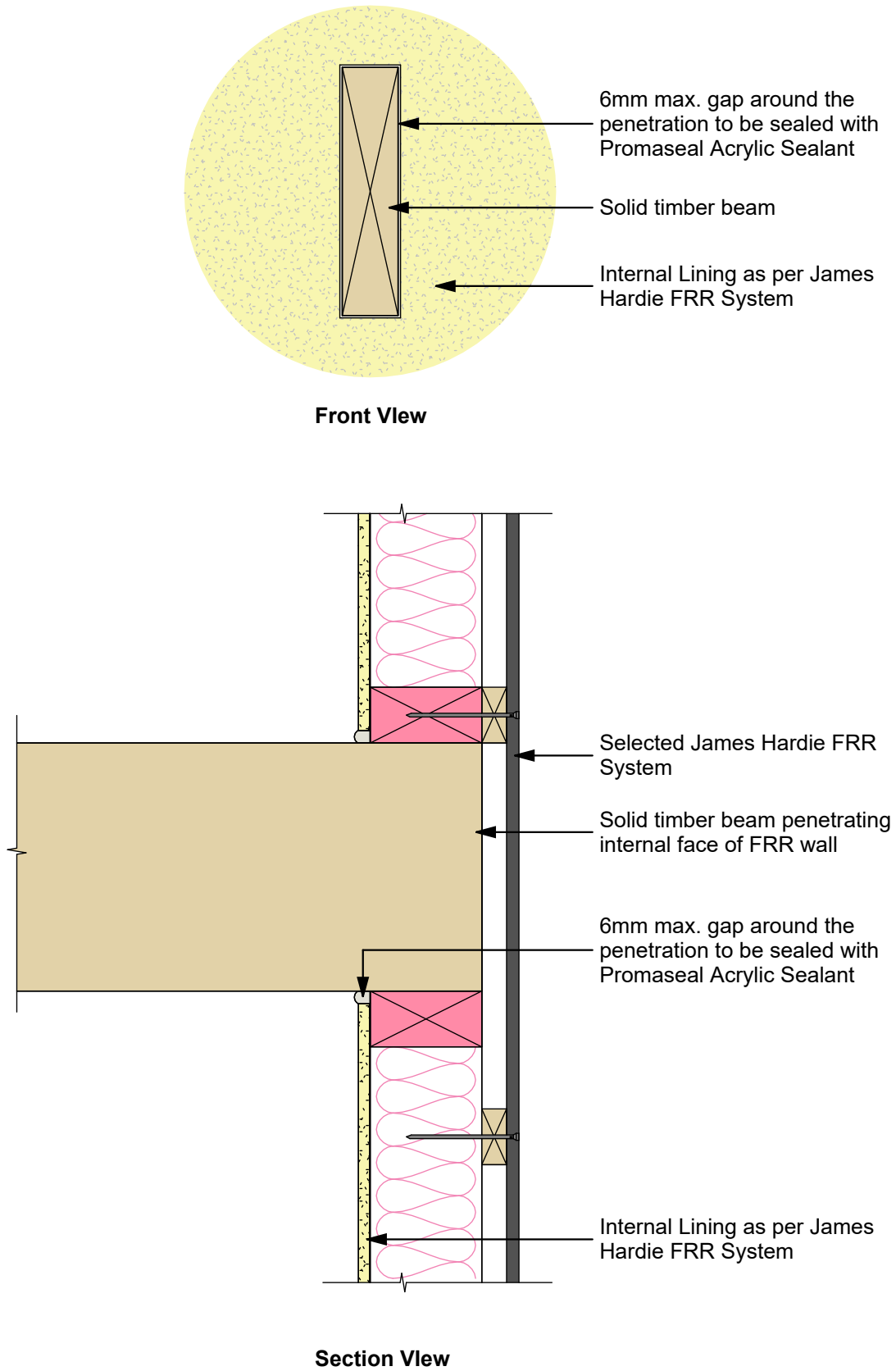

Figure 12: Intertency Wall Multi-Story Detail on Concrete Foundation

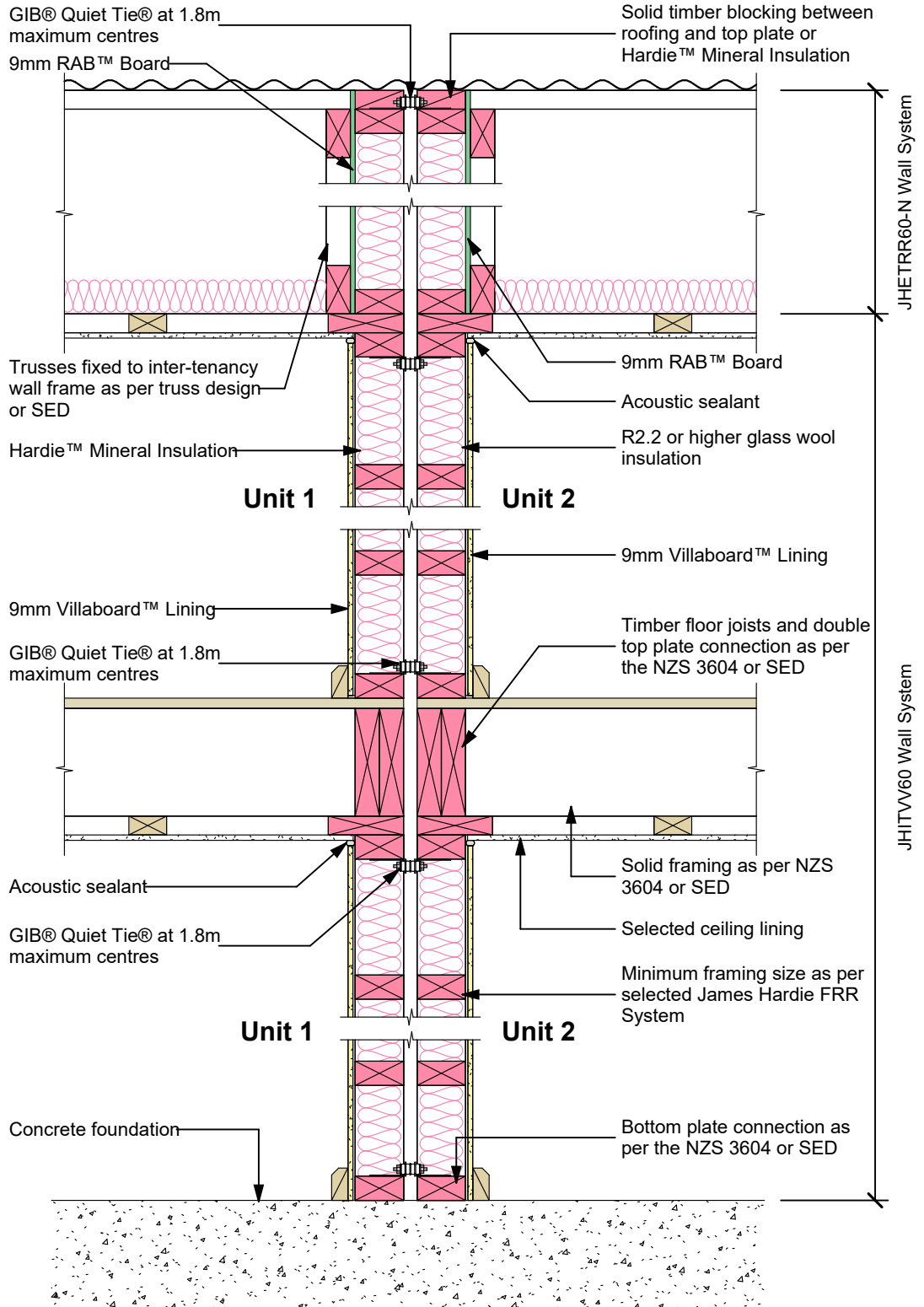

Figure 13: Intertenancy Wall Multi-Story Detail on Timber Foundation

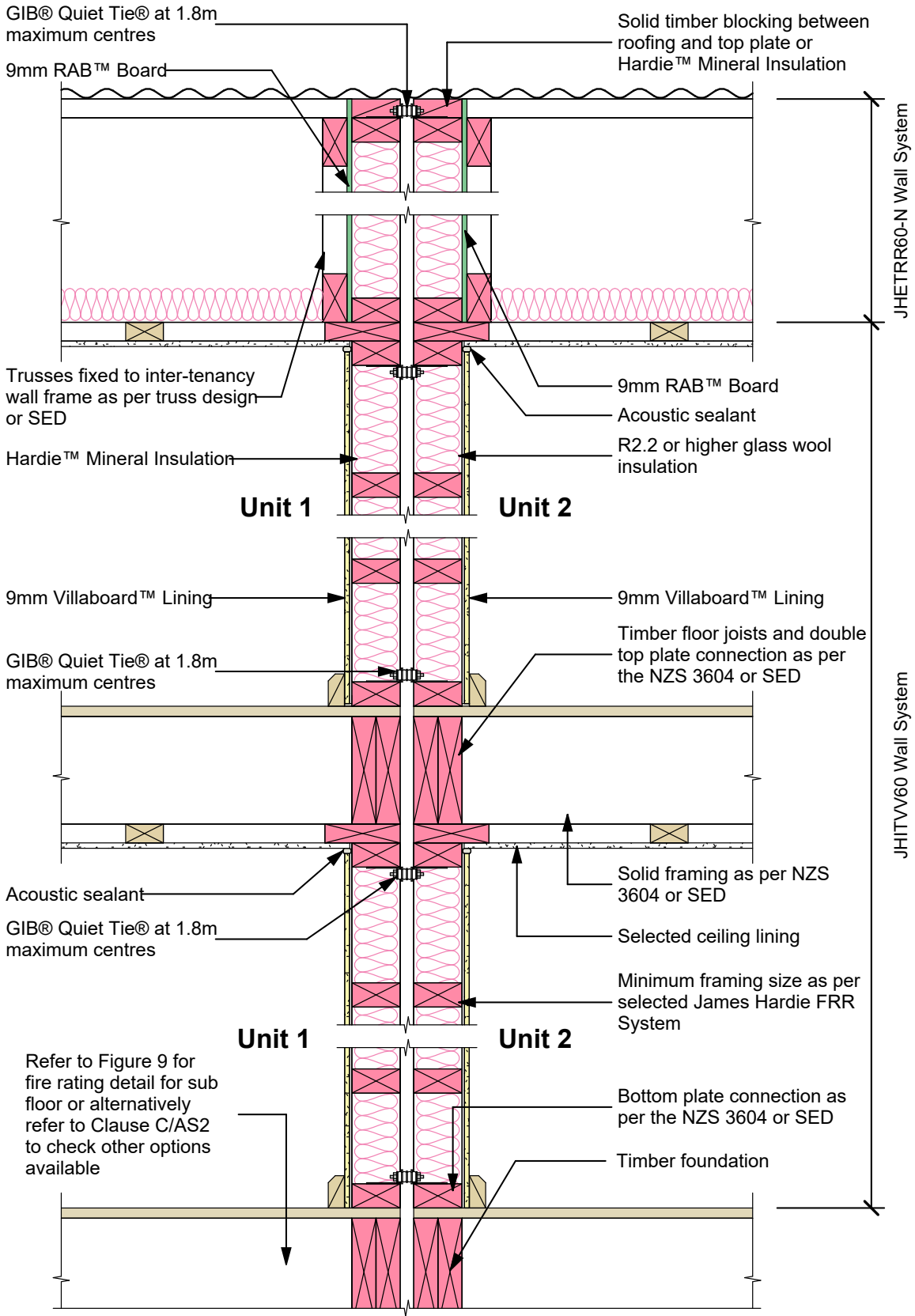

Figure 14: Wing wall – Linea™ Weatherboard

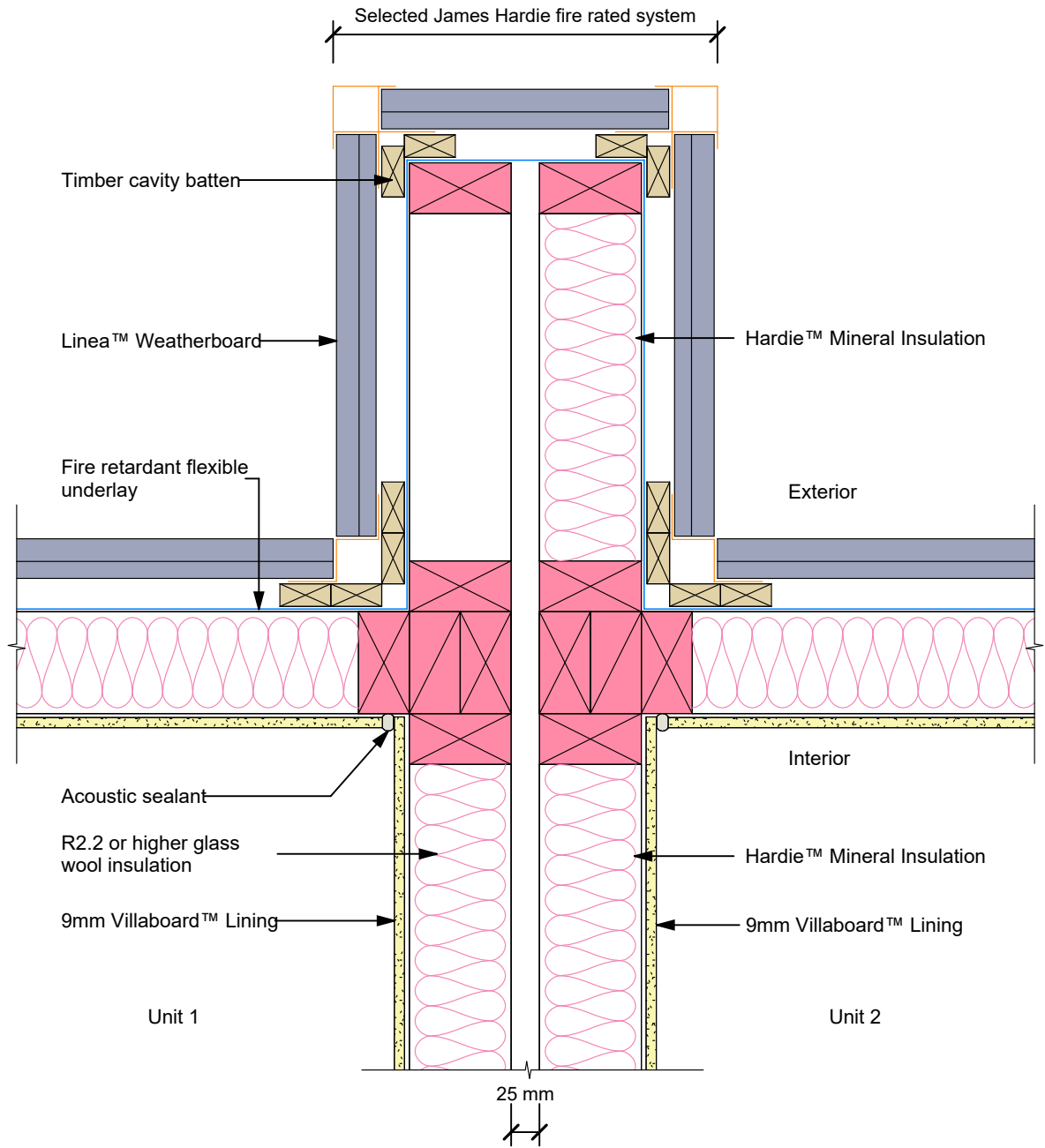

Figure 15: Wing wall RAB™ Board

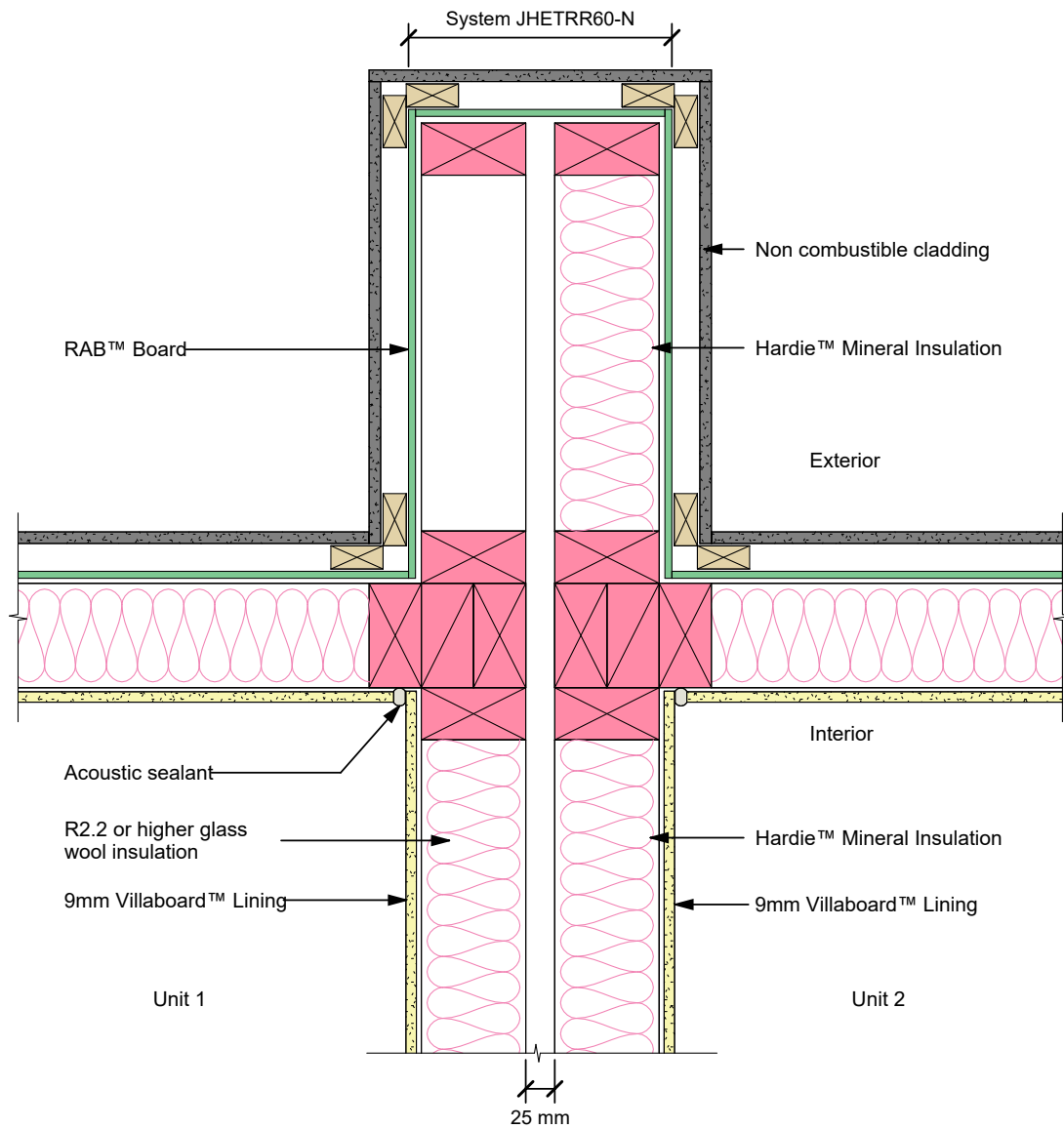

Figure 16: Control joint detail – Linea™ Weatherboard

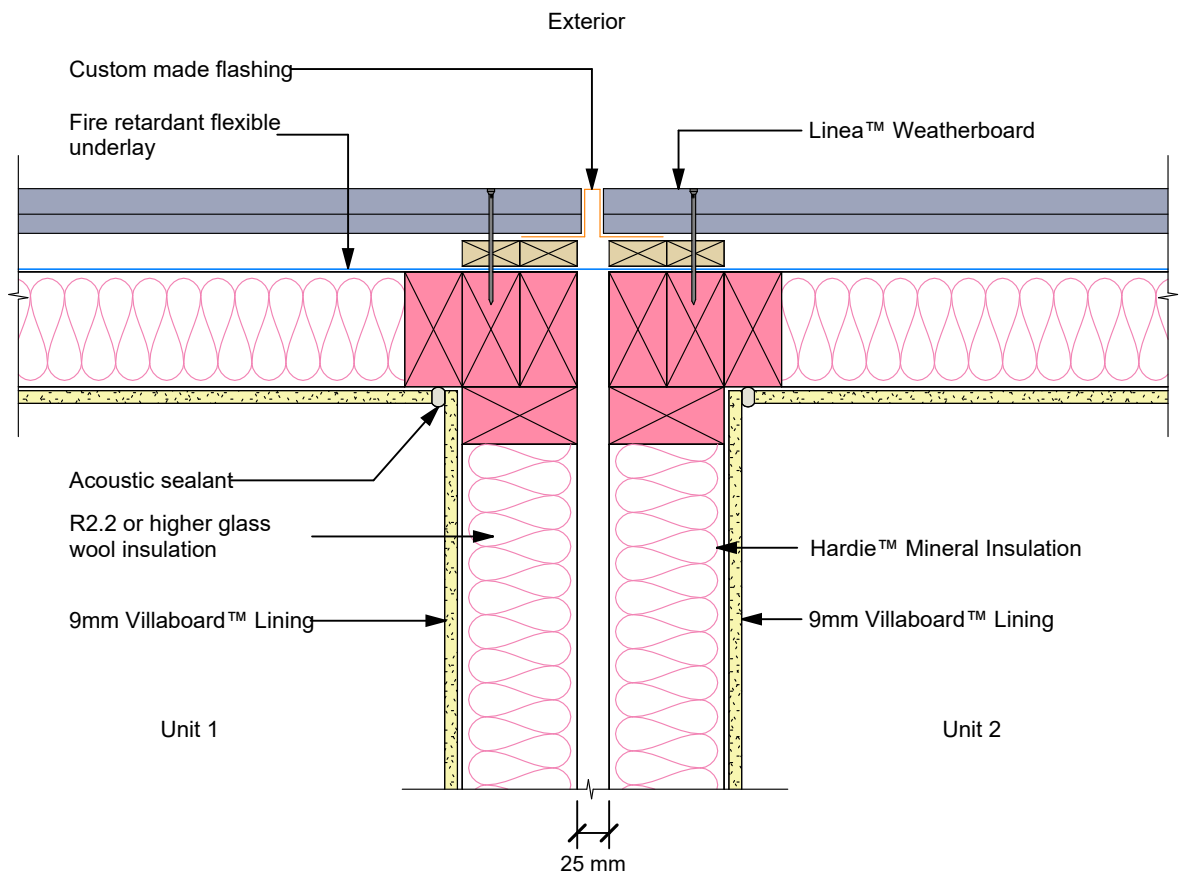

Figure 17: Vertical central joint detail

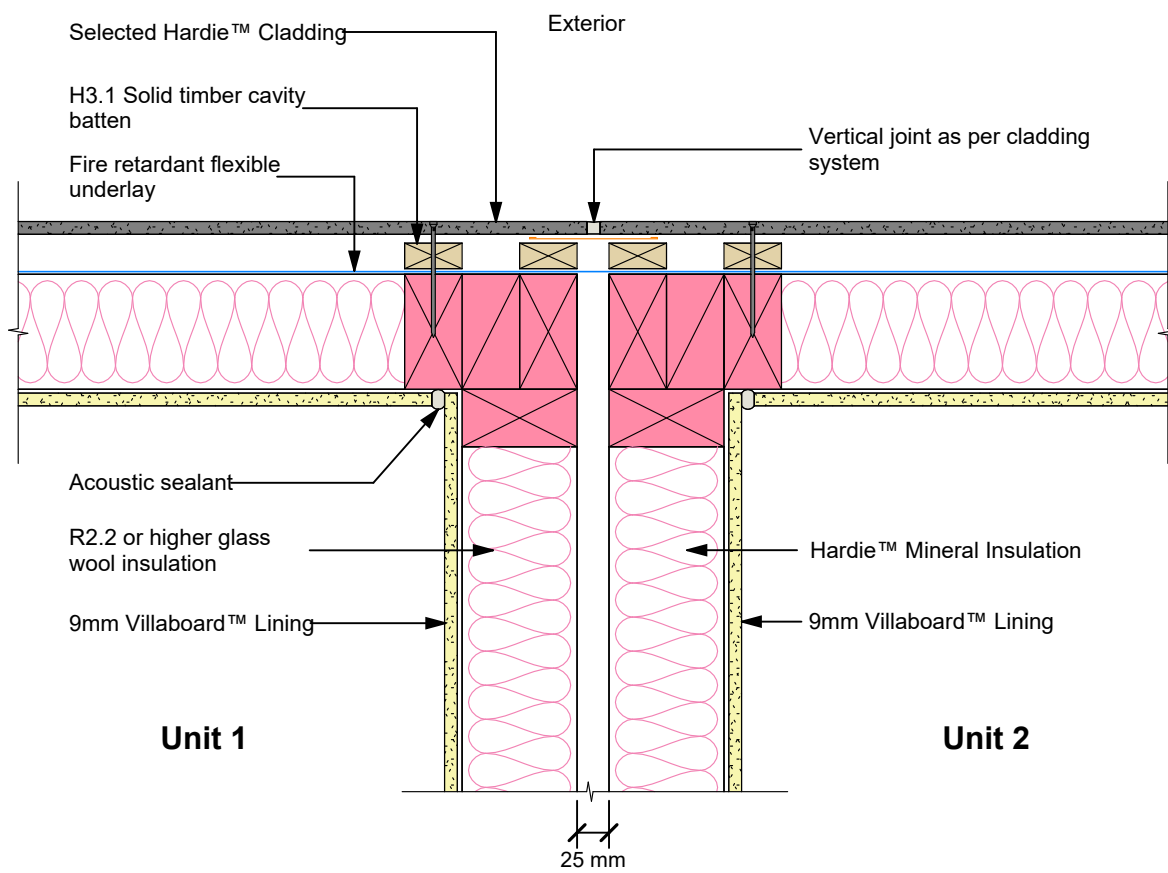
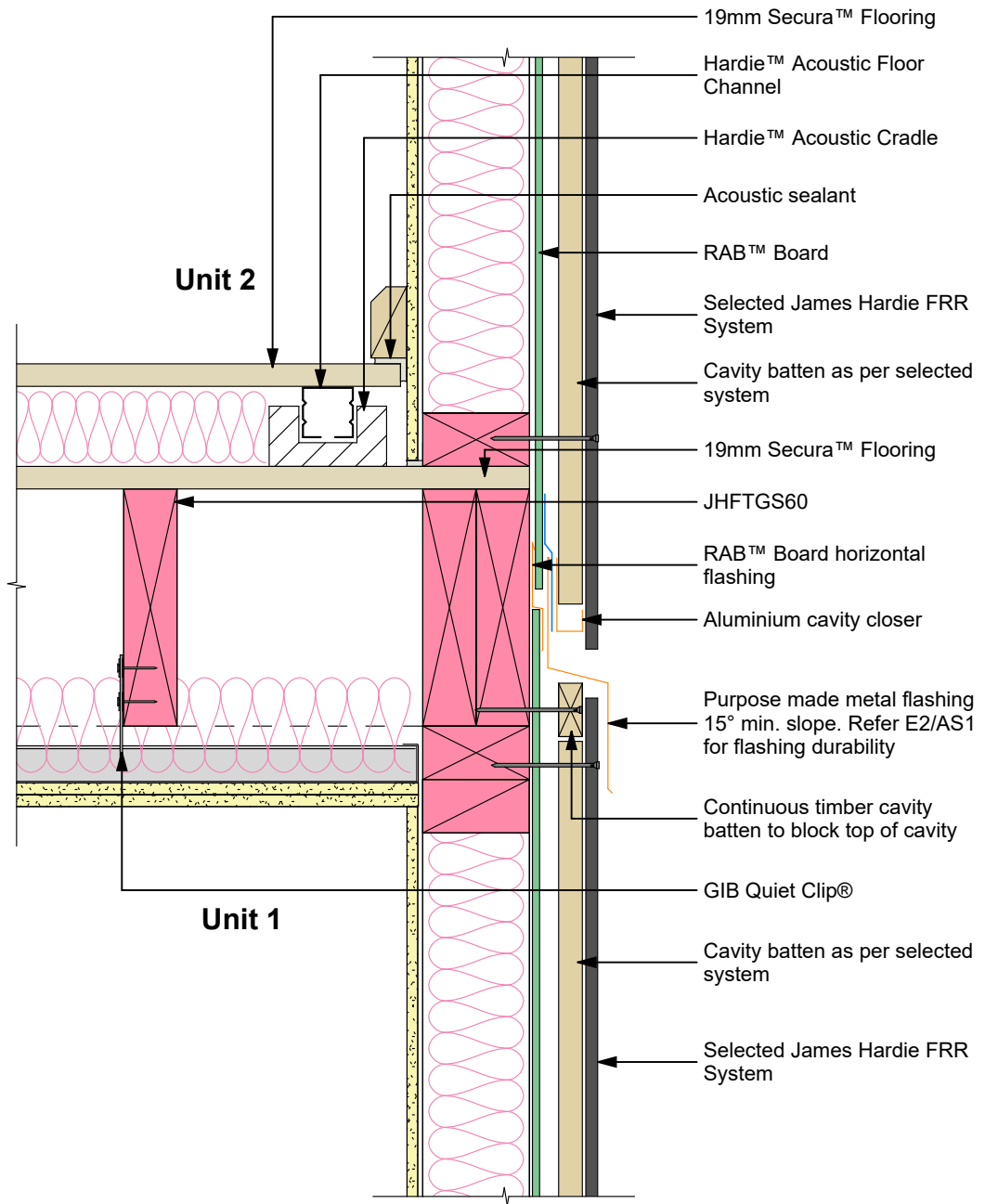

Figure 18: Intertency fire separation - over 10m building height



NOTE: Under 10m building height a flexible underlay can be used.

Figure 19: Timber floor to floor intertenancy wall junction

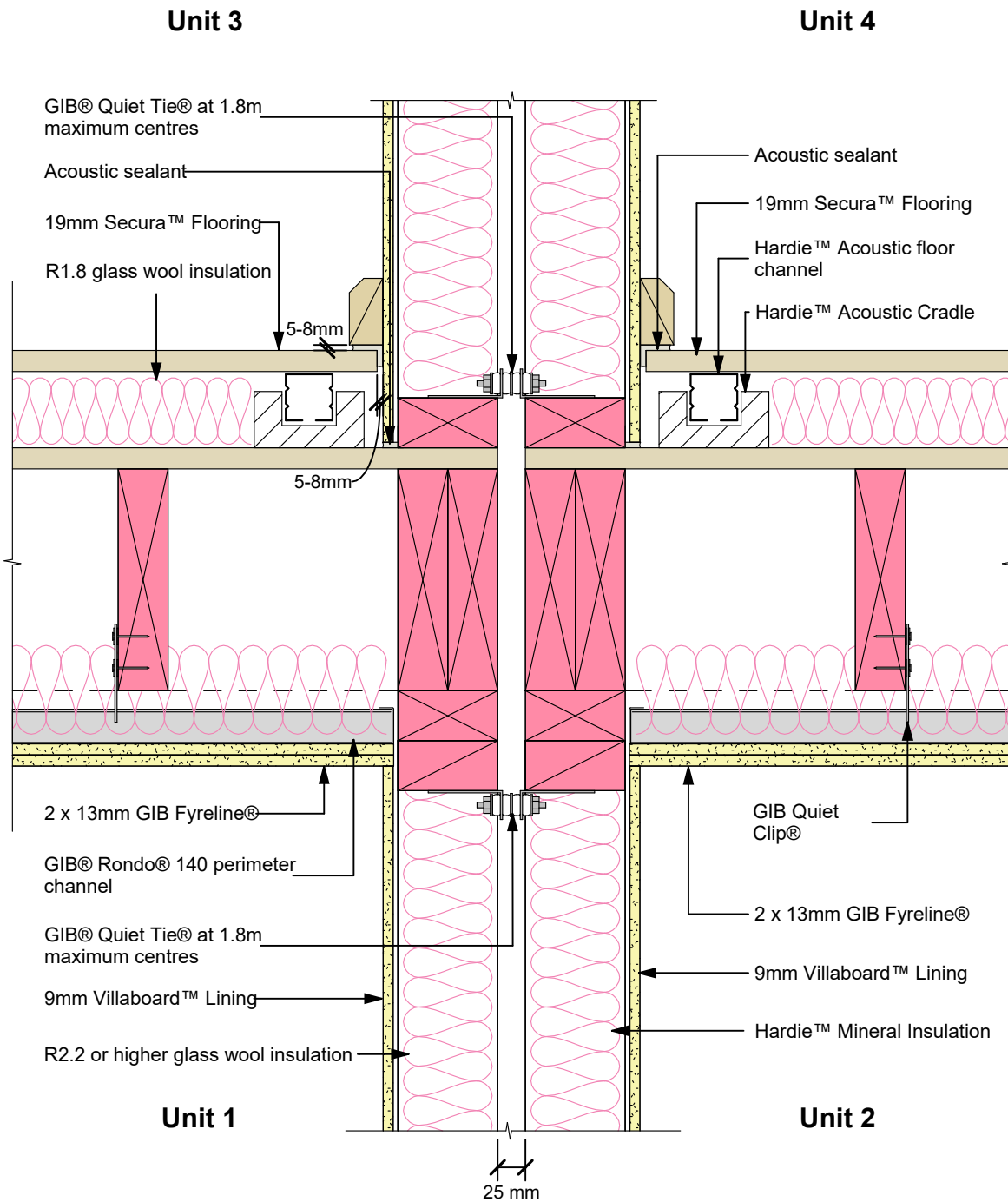
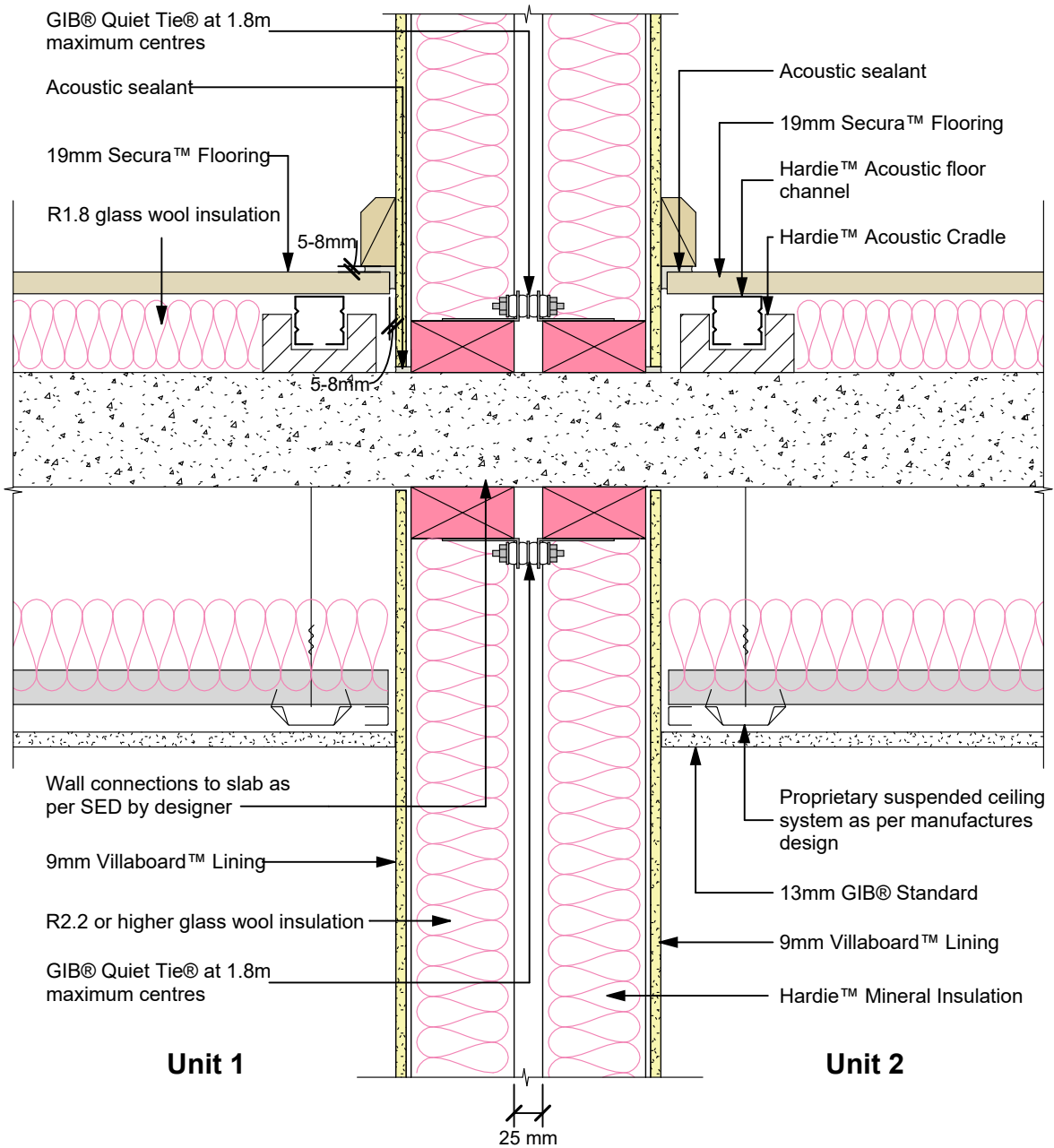

Figure 20: Concrete floor to floor intertenancy wall junction



5.1 Penetrations

Penetrations through fire and acoustically rated walls must be carefully considered by the designer at the design stage and suitable penetration details shall be selected for construction. Unconsidered or poorly planned penetrations through fire rated walls risk compromising the performance of James Hardie's fire rated systems. It is recommended, where possible, to pass the cables/ pipes through fire rated 'service ducts' or 'shafts' thus minimising the number of penetrations through fire rated walls.

Various penetration details are published in this design manual such as those given for metallic and non-metallic pipes, cable trays and switch boxes etc. have been developed based on fire testing and assessments completed by BRANZ. These penetrations, when constructed in accordance with the details included in this design manual will not be detrimental to fire performance of 30 or 60 minute James Hardie fire rated walls. A minimum edge distance of 200mm has been tested and must be maintained. Holes/penetrations positioned no closer than 200mm to another penetration, are allowed for services. Maximum of two service penetrations are recommended per sheet. A pipe/cable up to 20mm max can run between bottom plate and top plate clamped to the side of stud within a fire rated wall ensuring the insulation is tight fit around it. The pipe/cable up to 20mm max. can penetrate the bottom plate and top plated when installed in in the centre of the plates.

NZBC Acceptable Solution C/AS2 contains allowances for small unprotected areas within external fire rated walls as outlined in C/AS2 Sections 5.4 and 5.5. The designer must ensure that the total area of penetrations and other allowable openings within James Hardie's external fire rated walls does not exceed these allowances. James Hardie's external fire rated walls that have unprotected areas that exceed the allowances given in C/AS2 are outside the scope of this design manual and shall be specifically designed in all instances.

Figure 21: Penetration detail – Switch box

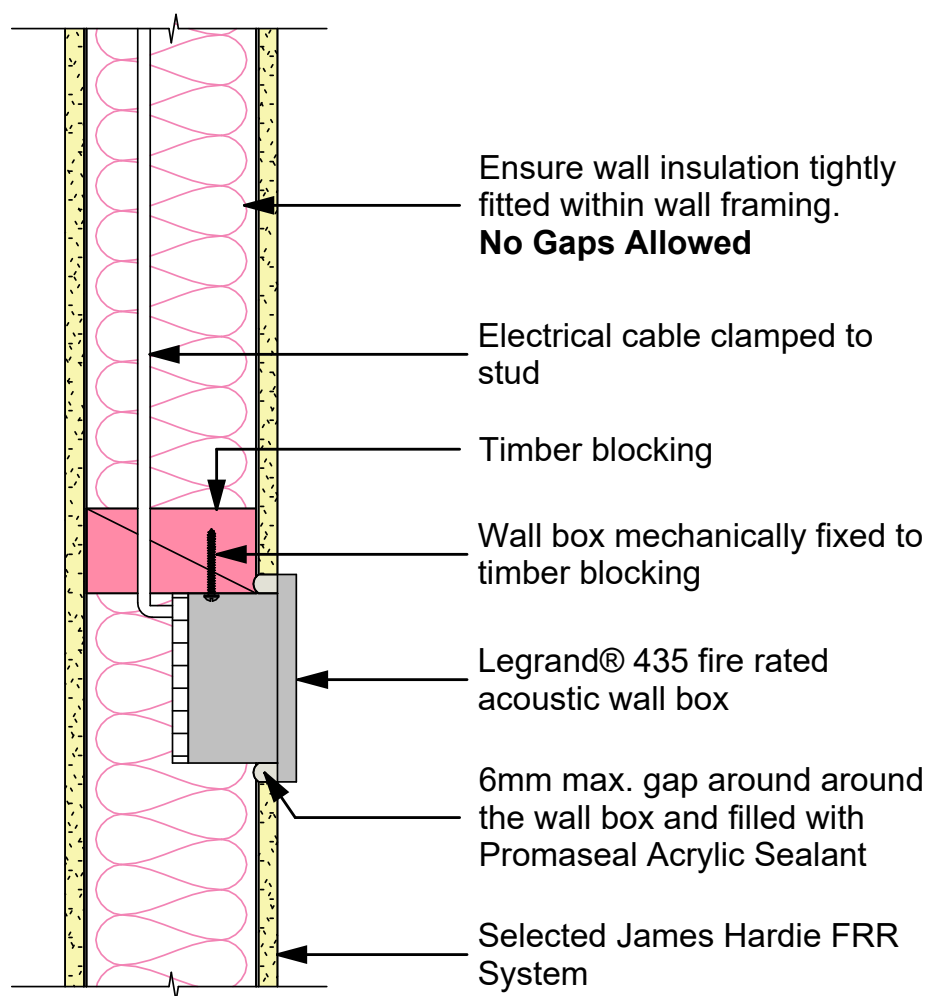

Figure 22: Penetration detail – HDPE/PEX/PEX-AL-PEX pipe, flexible underlay

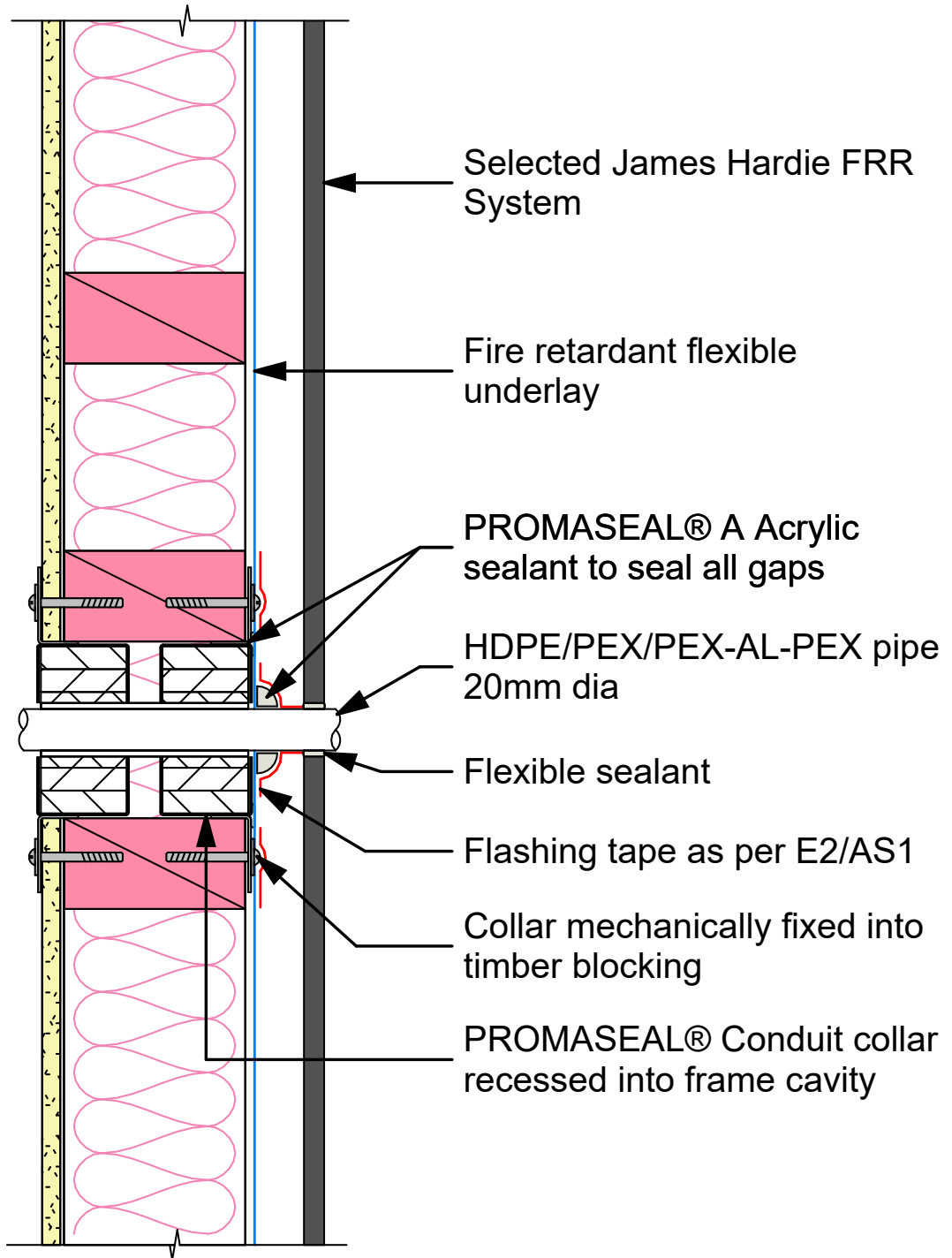

Figure 23: Penetration detail – uPVC pipe, flexible underlay

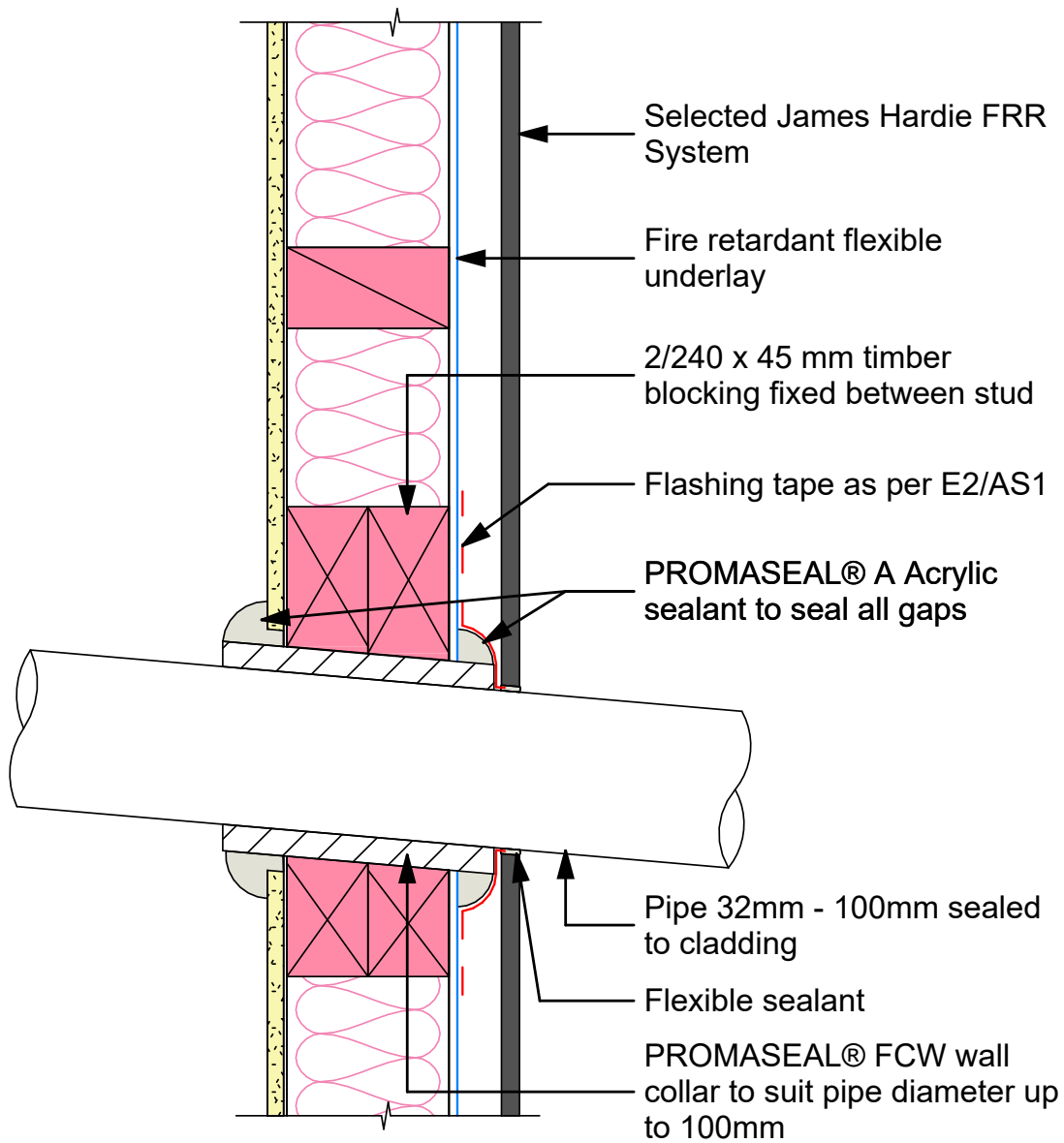

Figure 24: Penetration detail – uPVC pipe, RAB™ Board

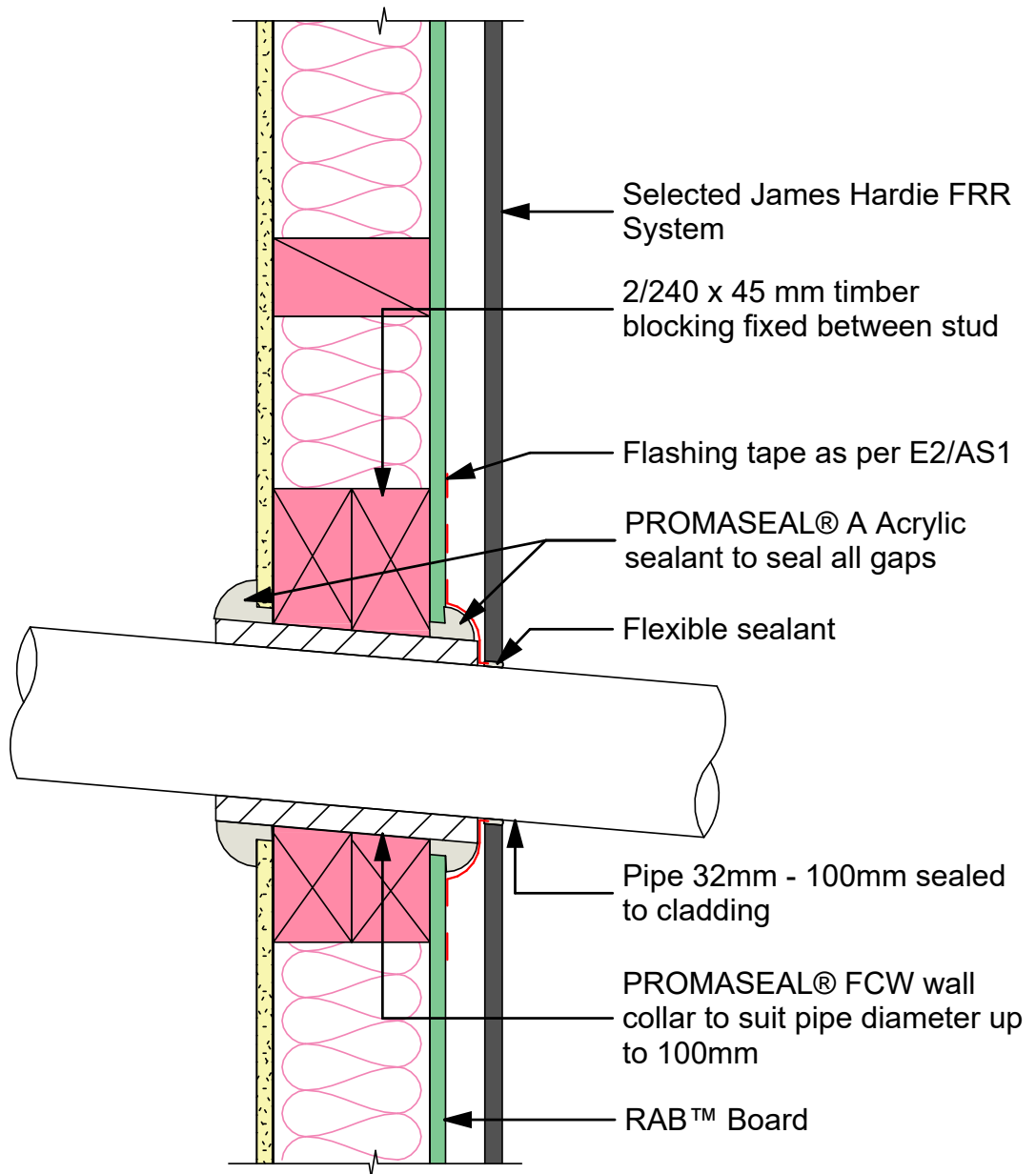

Figure 25: Penetration detail – Electrical cable /Copper pipe

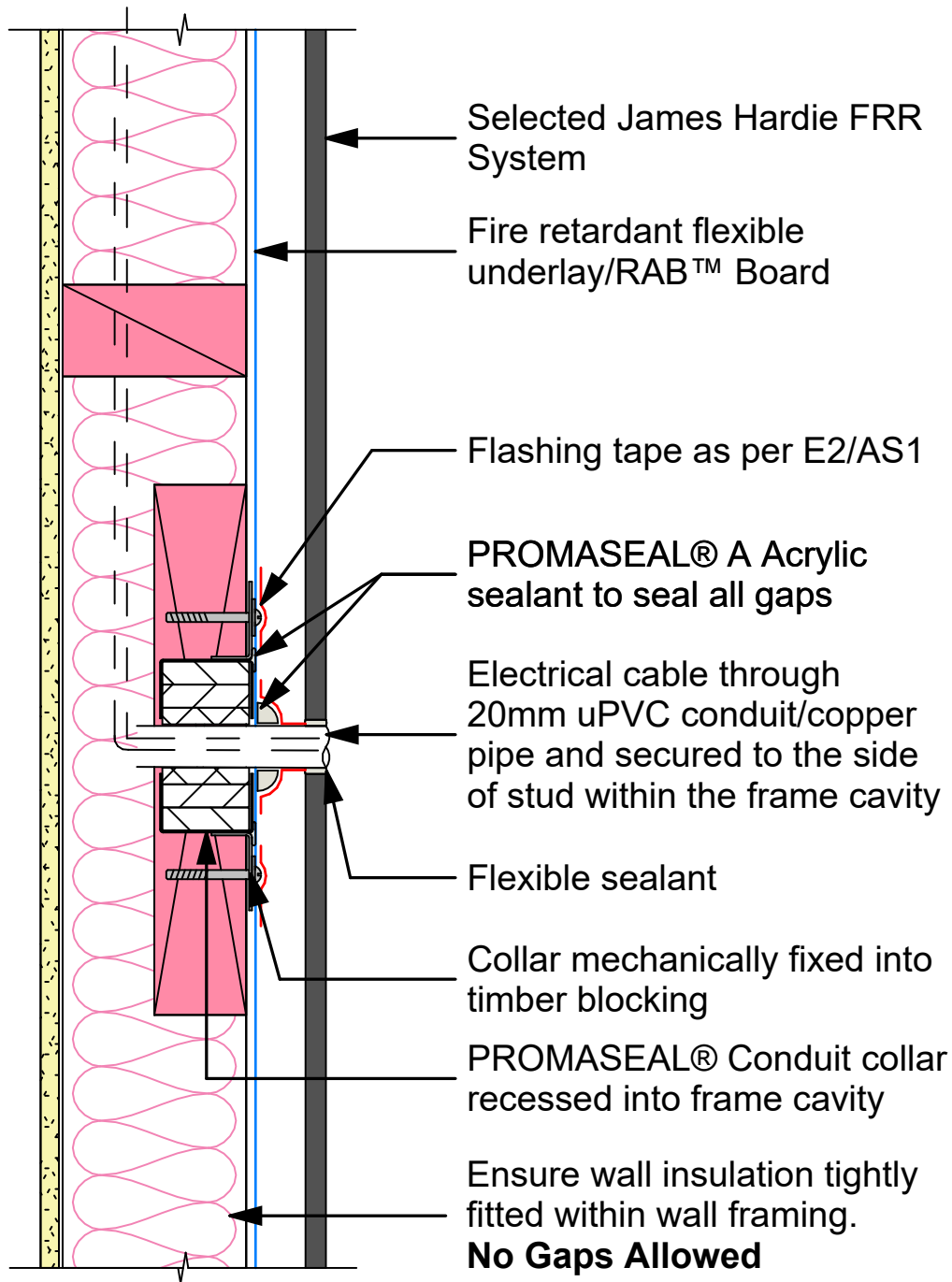
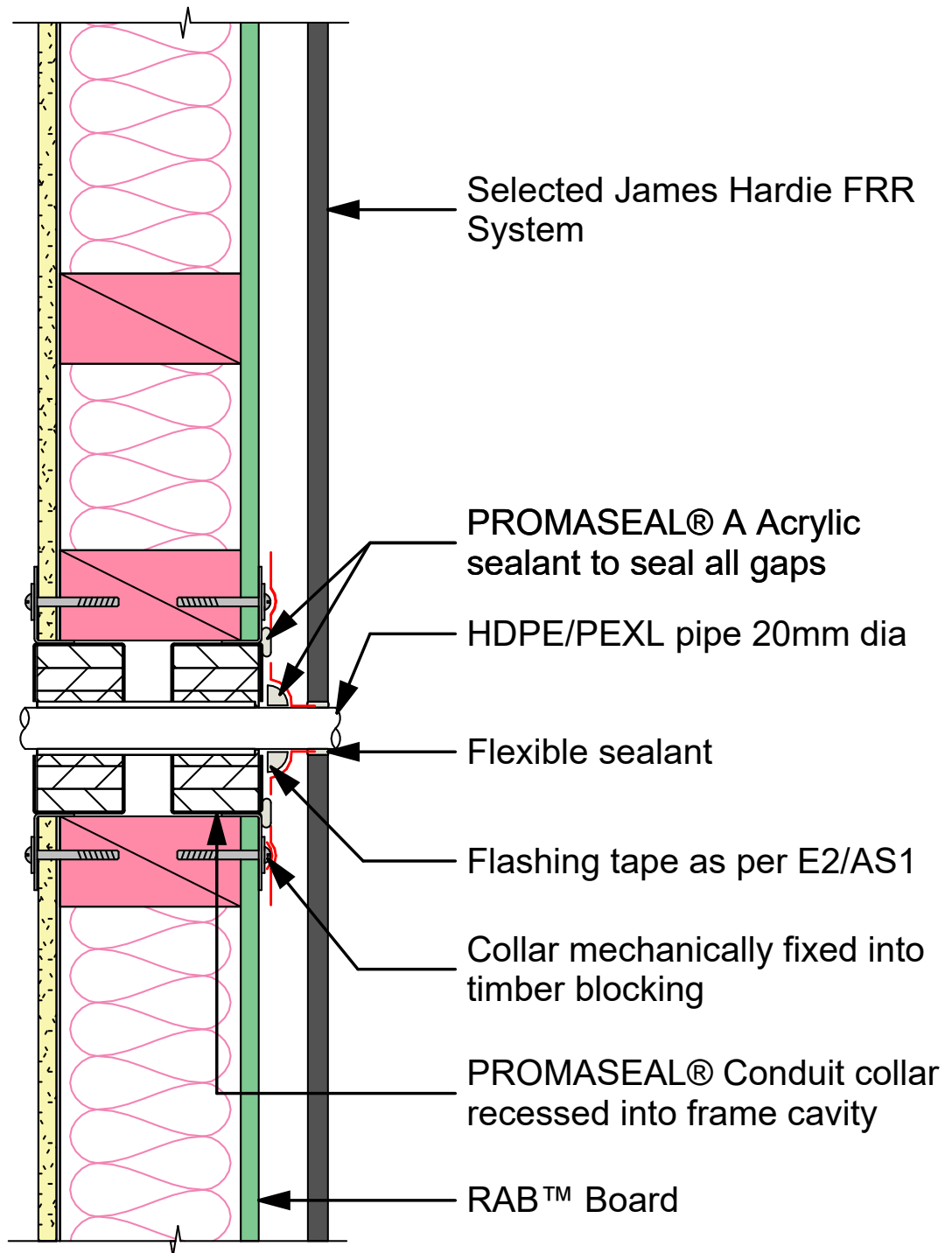

Figure 26: Penetration detail – HDPE/PEX pipe, RAB™ Board



6 Hardie™ Mineral Insulation

Hardie™ Mineral Insulation	Quantity/size (approx)
	800 x 600 x 90mm thick 2.4m ² per bale 5 pieces per bale Code: 304904

Storage

Hardie™ Mineral Insulation should be stored in the packaging provided in a clean dry space where it will not get wet, knocked or damaged.

Handling and safety

Protective clothing must be worn when handling this product.

Engineering Controls

In industrial situations, it is expected that employee exposure to hazardous substances will be controlled to a level as far below the WES as practicable by applying the hierarchy of control required by the Health and Safety at work Act (2015) and the Health and Safety at Work (General Risk and Workplace Management) Regulations 2016. Exposure can be reduced by process modification, use of local exhaust ventilation, capturing substances at the source, or other methods. If you believe air borne concentrations of mists, dusts or vapours are high you are advised to modify processes or increase ventilation. Follow the Health and Safety Guidelines for the Selection and Safe Handling of Synthetic Mineral Fibres, published by WorkSafe.

Personal Protective Equipment

Eyes: Avoid contact with eyes. Use safety glasses or goggles if irritant levels of fibres and dusts are present. Protective gloves and clothing should be worn when handling mineral insulation.

Skin: To prevent irritation which occurs by contact of the loose fibres with the skin, it is advisable to wear either disposable or single-use overalls or light weight nylon overalls complete with hoods when handling the insulation material. The overalls should be close fitting at the neck, wrists and ankles to prevent problems of skin irritation. When overalls are to be laundered, they should be laundered in separate laundry facilities and not in the home.

Respiratory: In general use, a respirator is not likely to be required. A respirator should be used when airborne concentrations approach the WES, if there is airborne dust or fibres. It is recommended to use a half face air purifying respirator with a minimum of a P1 particulate filter. If using a respirator, ensure that the cartridges are correct for the potential air contamination and are in good working order.

WES Additional Information

Formaldehyde is included in the above information, as traces of formaldehyde may be emitted from the product, especially immediately after removing the plastic packaging. The concentration of formaldehyde emissions have been tested by James Hardie New Zealand Limited and were found to be below the 8 hour workplace exposure standard.

Work Safe New Zealand Health and Safety Guidelines for the Selection and Safe Handling of Synthetic Mineral Fibres requires lightweight nylon overalls, gloves, appropriate eye protection and a respirator with a minimum of a class P1 filter. Handling the product as if it is fragile will greatly reduce the potential dust creation and loose fibres. A SDS is available by visiting www.jameshardie.co.nz or Ask James Hardie™ on 0800 808 868.

Cutting

A straight edge and stiff blade knife or similar will neatly cut this product with the minimum of dust creation. Cut the insulation 50mm over the size of the framing cavity to achieve the tight friction fit.

7 Product Warranty

Fire & Acoustic components supplied by James Hardie are backed by a warranty. The warranty period will vary based on the specific system component. For warranty terms & conditions refer to www.jameshardie.co.nz or Ask James Hardie™ on 0800 808 868.



Ask James Hardie™ | Call 0800 808 868 | jameshardie.co.nz

© 2026. James Hardie New Zealand Limited. TM and ® denotes a Trademark or Registered Mark owned by James Hardie Technology Limited.
GIB® Quiet Ties®, Braceline®, Noiseline®, Aqualine®, Toughline®, Fyreline®, Grabber®, Pyrda®, Handibrac® and USG Boral® and Elephant Plasterboard® are trademarks of their respective owners.



PRINTED PAPER DOCUMENT STOCK
The stock used is produced from EFC (Elemental Chlorine Free) pulp sourced from farmed Eucalyptus trees and is manufactured under the strict ISO14001 Environmental Management System

